



# MVCMP-X



**Belt-driven fans fitted with electric motors and a standardised set of pulleys, belts and protectors in accordance with standard ISO 13857**



**Fan:**

- Sheet steel casing
- Forward-curved impeller blades made of galvanised sheet steel
- Version A: motor assembled on the casing
- Version B: motor assembled on the general bench

**Motor:**

- IE3 efficiency motors for powers equal to or greater than 0.75 kW except single-phase, 2-speed and 8-pole
- Class F motors with ball bearings and IP55 protection
- Three-phase 230/400 V-50 Hz (up to 4 kW) and 400/690 V-50 Hz (powers higher than 4 kW)
- Maximum temperature of air to be carried: -20°C to +150°C

**Finish:**

- Anti-corrosive finish of polyester resin polymerised at 190°C, previously degreased with phosphate-free nanotechnological treatment

**On request:**

- Special windings for different voltages
- Fan prepared for air transmission of up to 250°C
- Stainless steel fan
- Category 2 ATEX certification
- Straight blade impellers



Shaft protections and transmission compliant with standards

**Direct drive motor construction method**

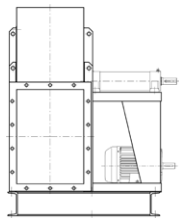

Transmission drive with the motor and fan mounted on the common bench. Motor positions "W" or "Z" and exceptionally "X" or "Y".

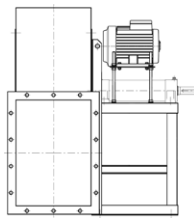

Transmission drive with the motor mounted on top of the pedestal, in position "W" or "Z".

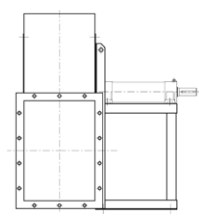

Transmission drive, impeller mounted on the support shaft. Support mounted on the pedestal.

**Technical characteristics**

Model	Speed (r/min)	Maximum admissible current (A)			Installed power (kW)	Maximum flow rate (m <sup>3</sup> /h)	Maximum pressure (mm H <sub>2</sub> O)	Approx. weight (kg)	Mounting version	According ErP
		230 V	400 V	690 V						
MVCMP-922-X-1 IE3	1600	2.82	1.62		0.75	2050	55	34	A	2015
MVCMP-922-X-1.5 IE3	1800	4.07	2.34		1.10	2300	65	42	A	2015
MVCMP-922-X-3 IE3	2270	7.93	4.56		2.20	2900	105	50	A	2015
MVCMP-922-X-4 IE3	2570	10.70	6.15		3.00	3300	135	57	A	2015
MVCMP-1025-X-2 IE3	1550	5.41	3.11		1.50	3000	60	56	A	2015
MVCMP-1025-X-3 IE3	1770	7.93	4.56		2.20	3400	80	57	A	2015
MVCMP-1025-X-4 IE3	1980	10.70	6.15		3.00	3800	100	64	A	2015
MVCMP-1128-X-2 IE3	1290	5.41	3.11		1.50	3550	55	61	A	2015
MVCMP-1128-X-3 IE3	1470	7.93	4.56		2.20	4050	75	62	A	2015
MVCMP-1128-X-4 IE3	1650	10.70	6.15		3.00	4550	95	69	A	2015
MVCMP-1128-X-5.5 IE3	1820	13.90	8.00		4.00	5000	115	78	A	2015
MVCMP-1128-X-7.5 IE3	2020		10.30	5.97	5.50	5550	140	113	B	2015
MVCMP-1231-X-4 IE3	1280	10.70	6.15		3.00	5050	60	74	A	2015
MVCMP-1231-X-5.5 IE3	1410	13.90	8.00		4.00	5600	70	83	A	2015
MVCMP-1435-X-3 IE3	1100	7.93	4.56		2.20	4850	70	74	A	2015
MVCMP-1435-X-4 IE3	1220	10.70	6.15		3.00	5350	90	81	A	2015
MVCMP-1435-X-5.5 IE3	1350	13.90	8.00		4.00	5850	110	90	A	2015
MVCMP-1435-X-7.5 IE3	1500		10.30	5.97	5.50	6500	135	125	A	2015

## Technical characteristics

Model	Speed (r/min)	Maximum admissible current (A)			Installed power (kW)	Maximum flow rate (m <sup>3</sup> /h)	Maximum pressure (mm H <sub>2</sub> O)	Approx. weight (kg)	Mounting version	According ErP
		230 V	400 V	690 V						
MVCMP-1435-X-10 IE3	1670		13.90	8.06	7.50	7250	170	125	A	2015
MVCMP-1640-X-4 IE3	1000	10.70	6.15		3.00	6650	65	99	A	2015
MVCMP-1640-X-5.5 IE3	1100	13.90	8.00		4.00	7350	80	108	A	2015
MVCMP-1640-X-7.5 IE3	1230		10.30	5.97	5.50	8200	100	143	A	2015
MVCMP-1640-X-10 IE3	1350		13.90	8.06	7.50	9000	120	143	A	2015
MVCMP-1845-X-5.5 IE3	1020	13.90	8.00		4.00	7250	115	118	A	2015
MVCMP-1845-X-7.5 IE3	1130		10.30	5.97	5.50	8000	140	153	A	2015
MVCMP-1845-X-10 IE3	1260		13.90	8.06	7.50	8950	170	153	A	2015
MVCMP-1845-X-15 IE3	1430		20.90	12.10	11.00	10150	220	200	B	2015
MVCMP-1845-X-20 IE3	1620		27.90	16.20	15.00	11500	285	208	B	2015
MVCMP-2050-X-7.5 IE3	900		10.30	5.97	5.50	11700	105	173	A	2015
MVCMP-2050-X-10 IE3	1000		13.90	8.06	7.50	13000	130	173	A	2015
MVCMP-2050-X-15 IE3	1130		20.90	12.10	11.00	14700	165	220	A	2015
MVCMP-2050-X-20 IE3	1270		27.90	16.20	15.00	16550	210	228	A	2015
MVCMP-2563-X-7.5 IE3	650		10.30	5.97	5.50	14200	65	253	A	2015
MVCMP-2563-X-10 IE3	720		13.90	8.06	7.50	15750	80	253	A	2015
MVCMP-2563-X-15 IE3	820		20.90	12.10	11.00	17950	105	300	A	2015
MVCMP-2563-X-20 IE3	920		27.90	16.20	15.00	20100	135	308	A	2015
MVCMP-2563-X-25 IE3	990		35.10	20.30	18.50	21650	155	362	B	2015
MVCMP-2563-X-30 IE3	1040		41.00	23.80	22.00	22750	170	368	B	2015



### Erp. (Energy Related Products)

Information on Directive 2009/125/EC: please consult with our technical department.

## Dimensions mm

MVCMP-X-922...2563  
Assembly A

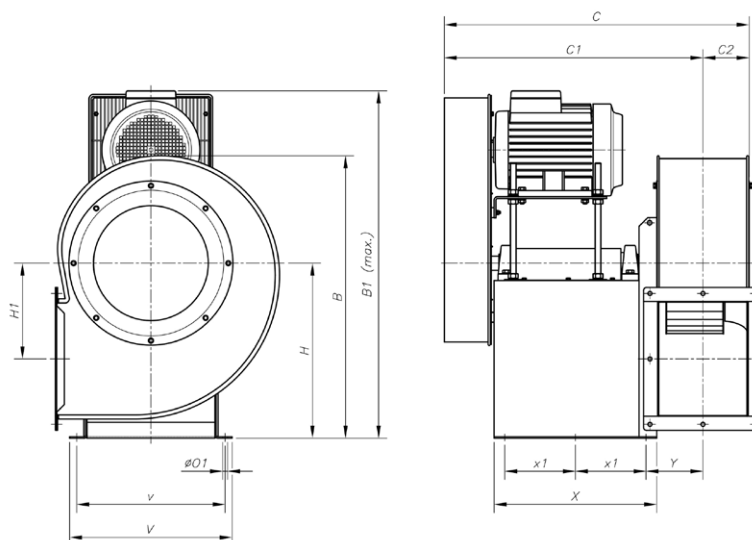

	A	B	B1	C	C1	C2	E	H	H1	øO1	V	v	X	X1	Y
MVCMP-922-X	388.5	455	655	589	515.5	73.5	180	280	134	12	340	310	350	150	100
MVCMP-1025-X	427	503	690	614	528	86	197	310	144	12	340	310	350	150	112.5
MVCMP-1128-X	472	553	725	660	566.5	93.5	216	340	152	12	350	320	380	160	125
MVCMP-1231-X	526	630	775	680	576.5	103.5	238	390	179.5	12	380	350	380	160	135
MVCMP-1435-X	573.5	715	940	838	720	118	250	445	242.5	12	440	400	460	200	149
MVCMP-1640-X	634	799	990	862	732	130	270	495	271	12	460	420	460	200	161
MVCMP-1845-X	711	901	1055	896	749	147	302	560	305	12	500	460	460	200	178
MVCMP-2050-X	797	987	1215	1068	905.5	162.5	345	610	313	14	540	500	600	275	189.5
MVCMP-2563-X	1027	1213	1350	1165	954	211	460	742	378.5	14	590	540	600	275	238



**Dimensions mm**

MVCMP-X-1128...2563  
Assembly B

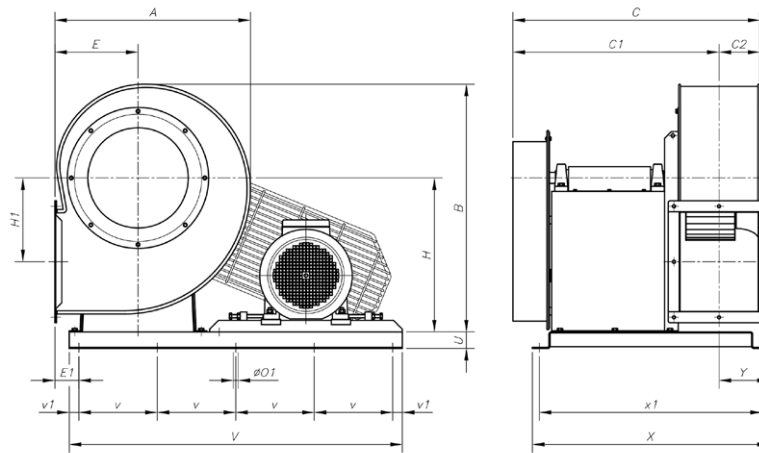

	A	B	C	C1	C2	E	E1	H	H1	øO1	U	V	v(*)	v1	X	X1	Y
MVCMP-1128-X	472	553	704	610.5	93.5	216	71	340	152	12	35	885	275	30	630	600	118
MVCMP-1231-X	526	630	724	620.5	103.5	238	118	390	179.5	12	35	980	280	70	660	630	138
MVCMP-1845-X	711	901	896	749	147	302	87	560	305	18	60	1210	285	35	860	810	182
MVCMP-2563-X	1027	1213	1165	954	211	460	195	742	378.5	18	60	1320	315	30	1200	1150	317

\*Mod. 1128 - 1231 = 4 holes. Mod. 1458 - 2563 = 5 holes.

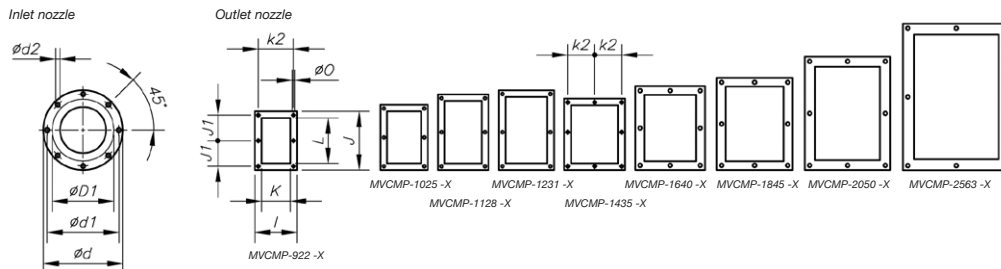

	øD1	ød	ød1	ød2	I	J	J1	K	k1	k2	L	øO
MVCMP-922-X	224	278	256	M8	204	282.5	128	140	-	180	215	9.5
MVCMP-1025-X	250	305	282	M8	229	312.5	145	165	-	205	250	9.5
MVCMP-1128-X	280	348	320	M8	244	364	170	180	-	220	296.5	9.5
MVCMP-1231-X	315	382	354	M8	264	382.5	180	200	-	240	320	11.5
MVCMP-1435-X	355	422	394	M8	292	342.5	159	228	133	-	280	11.5
MVCMP-1640-X	400	464	438	M8	336	404	185	250	150	-	321	11.5
MVCMP-1845-X	450	515	485	M8	370	444	202	284	164	-	361	11.5
MVCMP-2050-X	500	565	535	M10	411	544	250	315	182.5	-	451	11.5
MVCMP-2563-X	630	710	675	M12	512	706	330	410	230	-	600	17

\*Recommended nominal tube diameter

### Characteristic curves

Q = Flow rate in m<sup>3</sup>/h, m<sup>3</sup>/s and cfm.

Pe = Static pressure in mm H<sub>2</sub>O, Pa and inwg.

## MVCMP-X 922

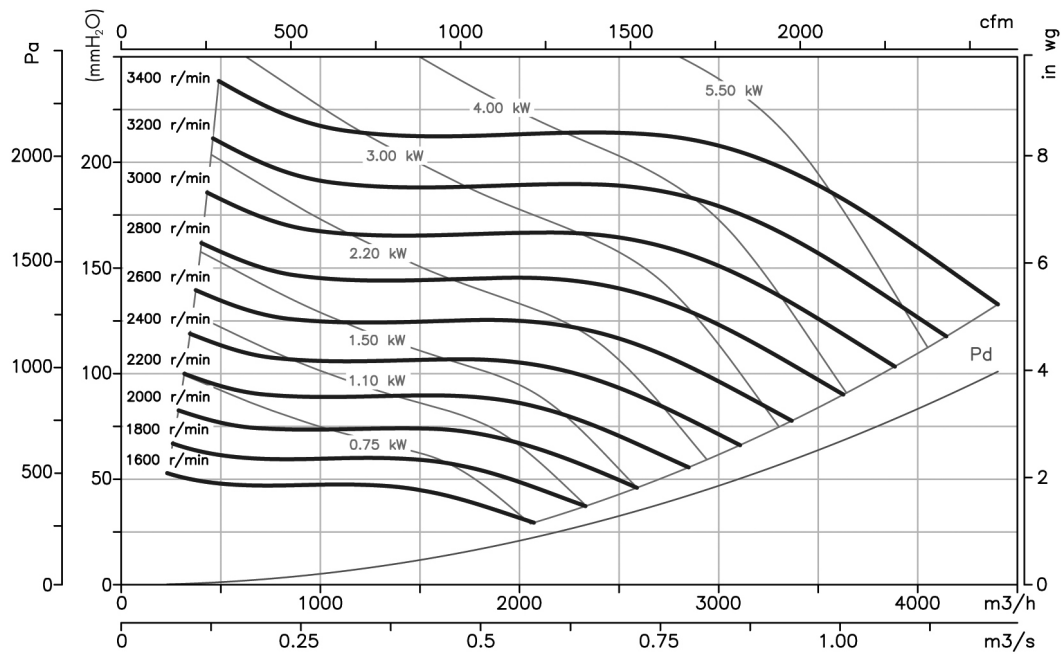

## MVCMP-X 1025

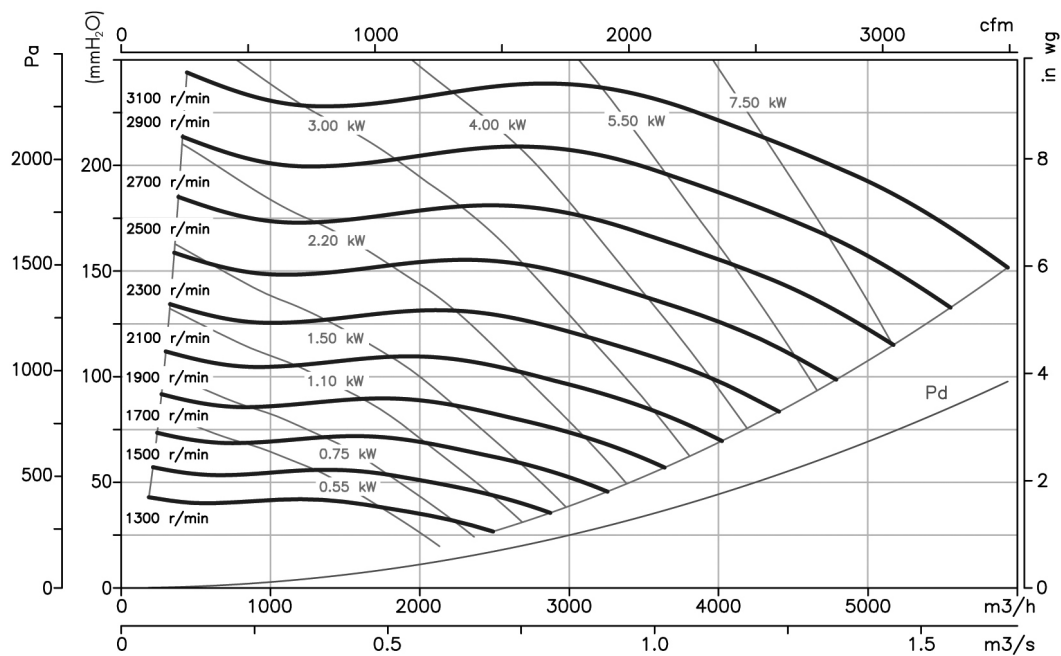



**Characteristic curves**

Q = Flow rate in m<sup>3</sup>/h, m<sup>3</sup>/s and cfm.

Pe = Static pressure in mm H<sub>2</sub>O, Pa and inwg.

**MVCMP-X 1128**

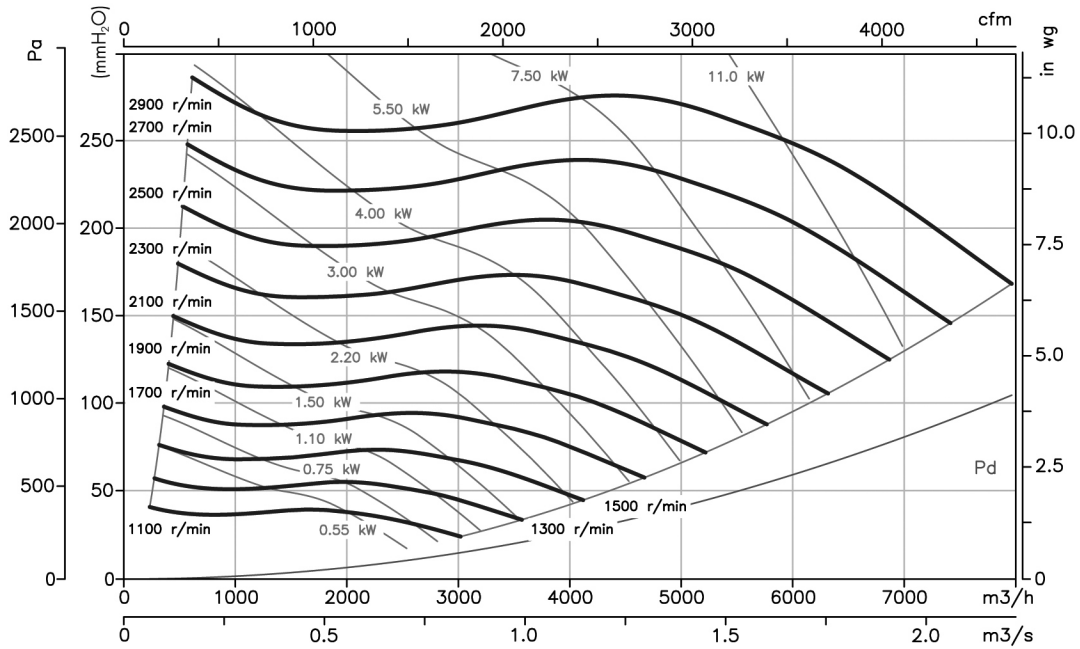

**MVCMP-X 1231**

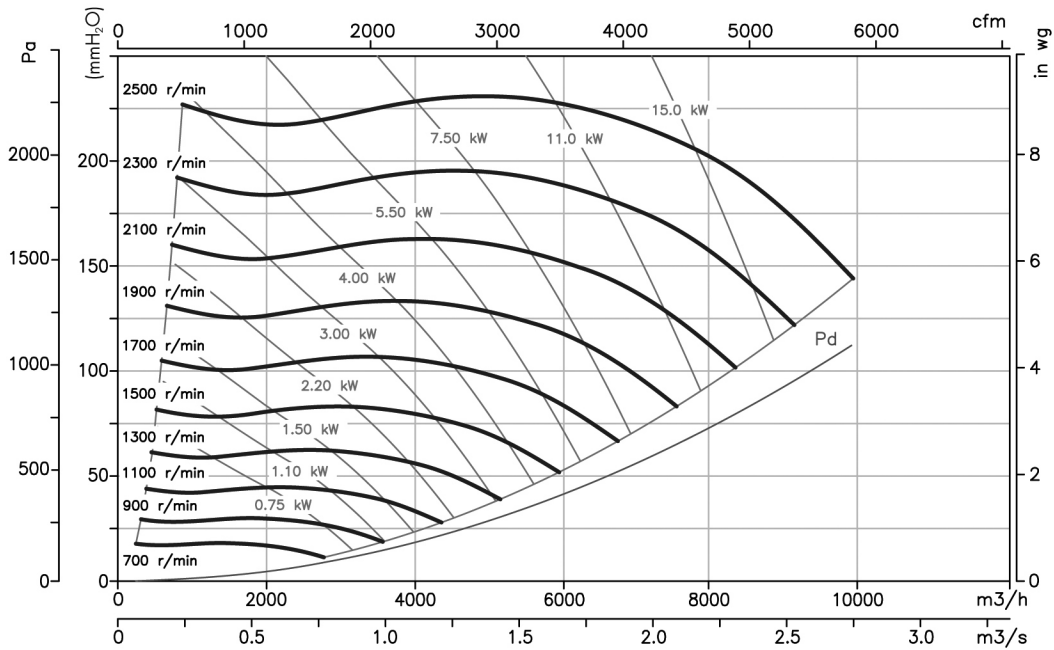

### Characteristic curves

Q = Flow rate in m<sup>3</sup>/h, m<sup>3</sup>/s and cfm.

Pe = Static pressure in mm H<sub>2</sub>O, Pa and inwg.

## MVCMP-X 1435

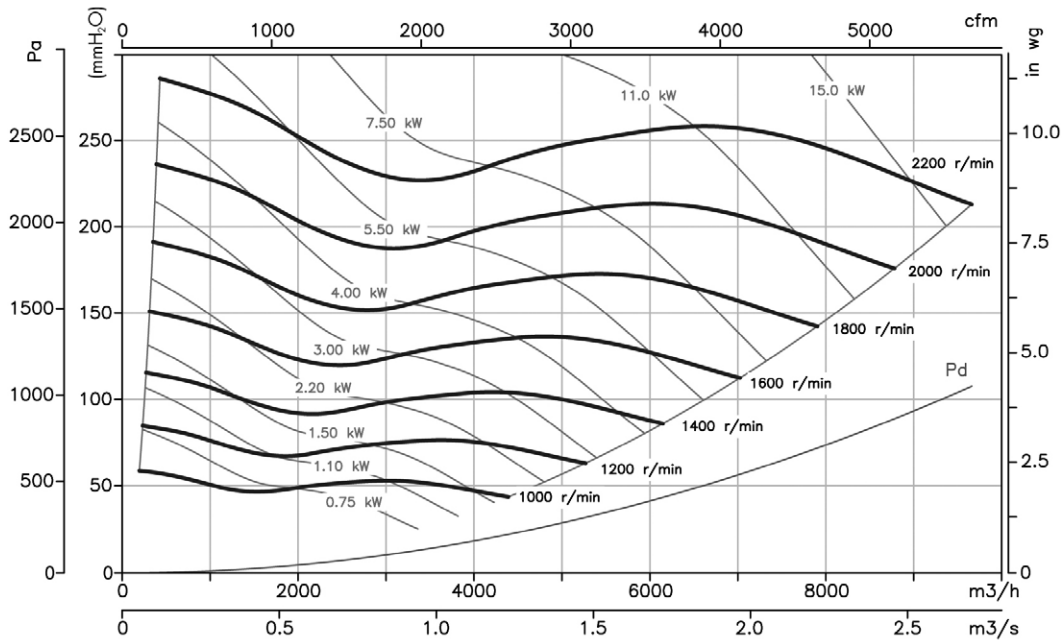

## MVCMP-X 1640

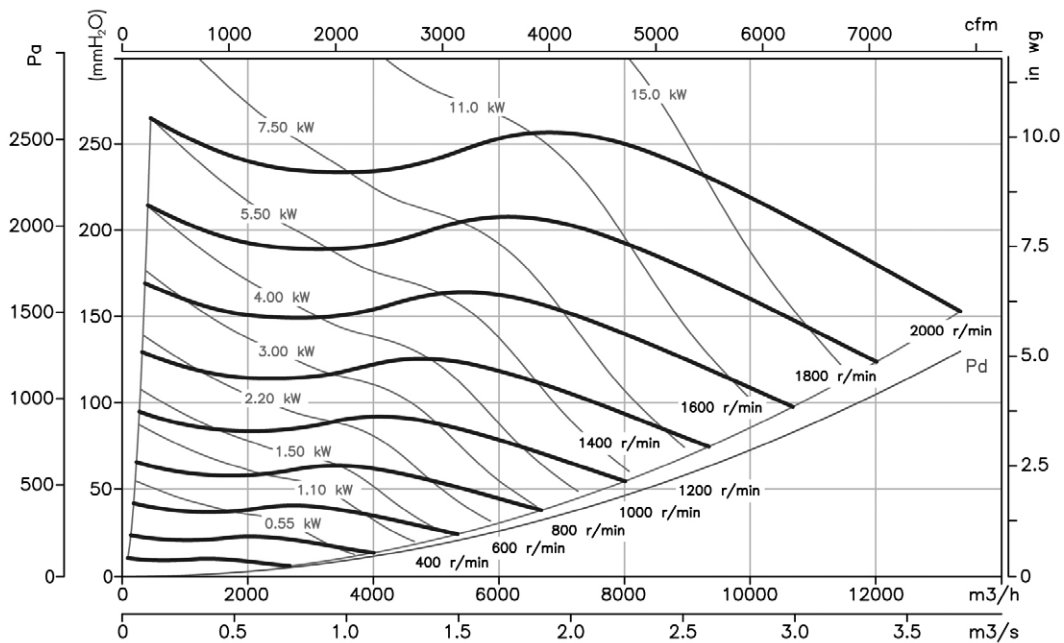



**Characteristic curves**

Q = Flow rate in m<sup>3</sup>/h, m<sup>3</sup>/s and cfm.

Pe = Static pressure in mm H<sub>2</sub>O, Pa and inwg.

**MVCMP-X 1845**

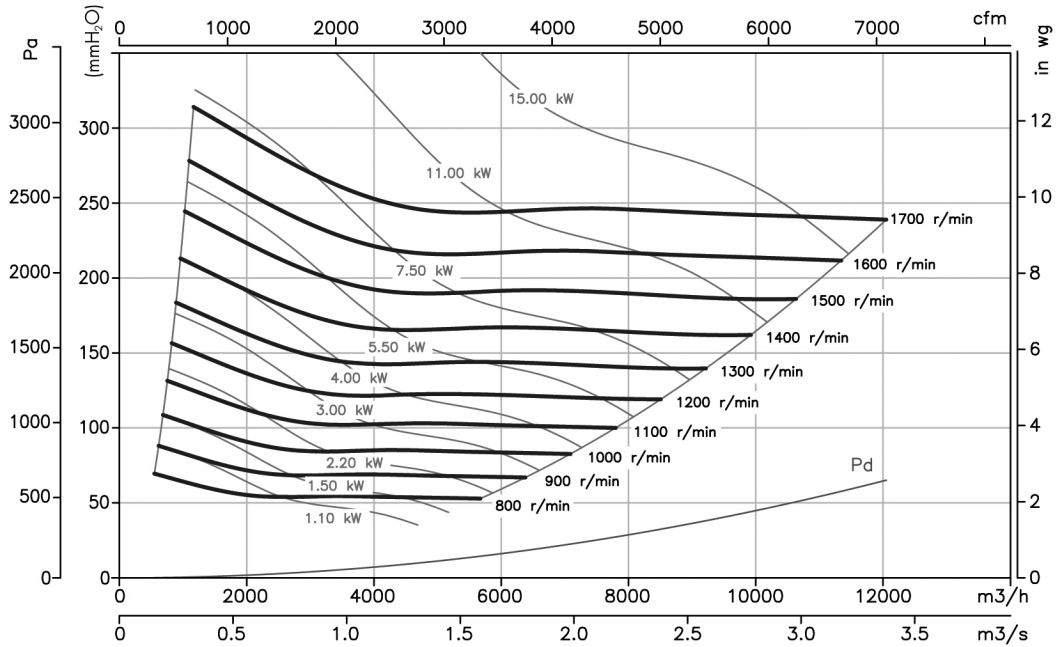

**MVCMP-X 2050**

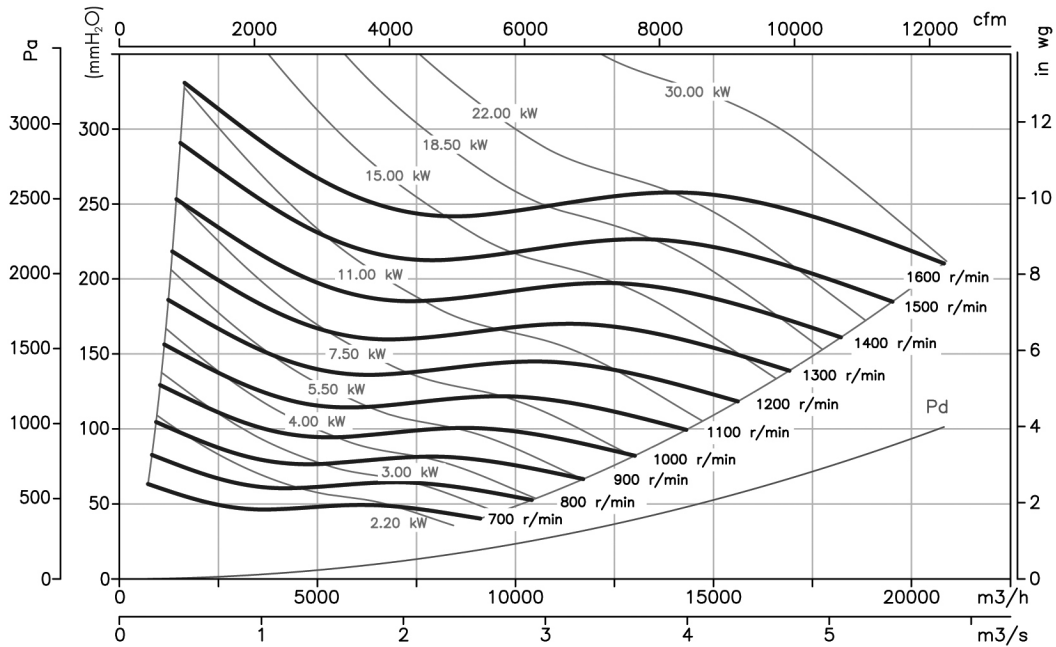

### Characteristic curves

Q = Flow rate in m<sup>3</sup>/h, m<sup>3</sup>/s and cfm.

Pe = Static pressure in mm H<sub>2</sub>O, Pa and inwg.

## MVCMP-X 2563

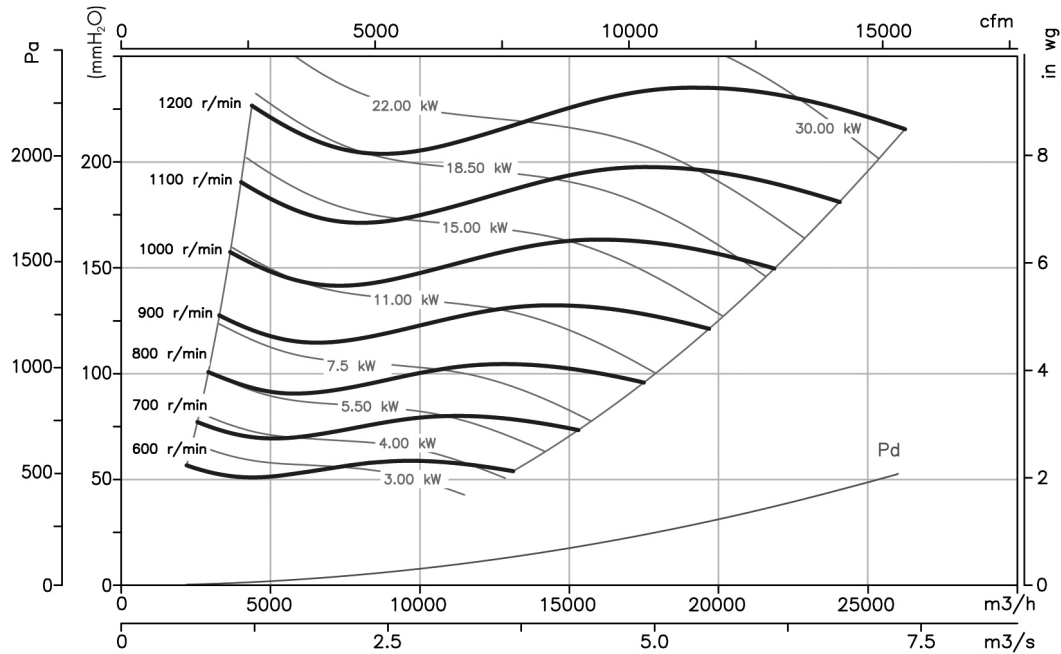

### Orientations

Standard supply LG 270

RD 0 RD45 RD90 RD135 RD180 RD225 RD270 RD315

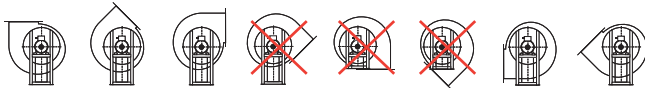

LG 0 LG45 LG90 LG135 LG180 LG225 LG270 LG315

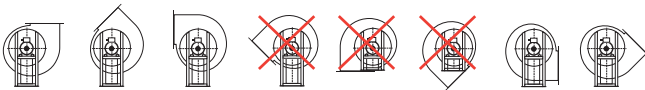

### Accessories

See accessories section.

