

MVHGT MVHGTX

MVHGT: Large diameter cased axial fans with direct drive motors

MVHGTX: Large diameter cased axial fans with external motors



Cased axial fans fitted with aluminium impellers with 6 or 9 blades and different angles of inclination.

Fan:

- Airflow direction from motor to impeller.
- Impellers made of cast aluminium with 6 or 9 blades with adjustable angle of inclination.
- Cased sheet steel casing.
- MVHGT: The standard version has a short casing. The long cased version is fitted with an inspection hatch.
- MVHGTX: Standard long cased version fitted with an inspection hatch.

Motor:

- IE3 efficiency motors for powers equal to or higher than 0.75 kW except single-phase, 2-speed and 8-pole.
- Class F motors with ball bearings and IP55 protection.

- Three-phase 230/400 V-50 Hz (up to 4 kW) and 400/690 V-50 Hz (powers higher than 4 kW).
- Operating temperature:
MVHGT: -25°C to +50°C
MVHGTX: -25°C to +120°C

Finish:

- Anti-corrosive finish of polyester resin polymerised at 190°C, previously degreased with phosphate-free nanotechnological treatment.

On request:

- Airflow direction from impeller to motor.
- 100% reversible impellers.
- Special windings for different voltages.
- Category 2 ATEX certification.
- MVHGT: Long cased fans fitted with an inspection hatch.
- Two-speed motors.

Order code

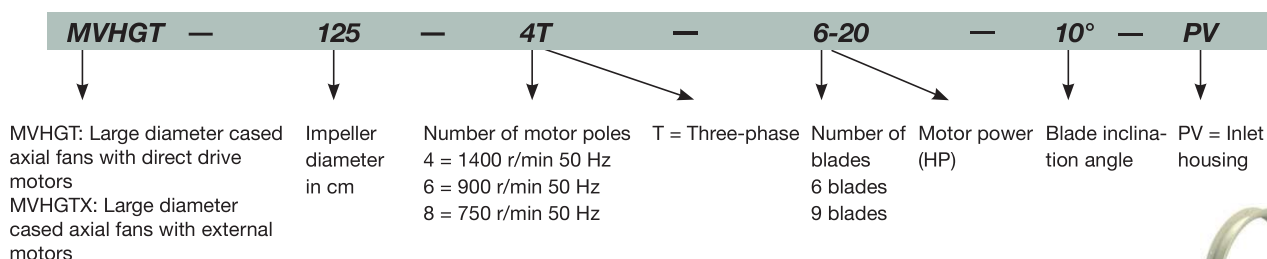

Technical characteristics

Model	Speed (r/min)	Maximum admissible current (A)			Installed Power (kW)	Maximum flow rate (m³/h)	Sound pressure level dB(A)	Approx. weight (kg)			According ErP
		230 V	400 V	690 V				MVHGT Long	MVHGTX Short	MVHGTX Long	
MVHGT MVHGTX 125-4T/6-20 IE3	1465		27.90	16.20	15.00	78300	89	294	266	414	2015
MVHGT MVHGTX 125-4T/6-25 IE3	1470		35.10	20.30	18.50	92000	90	372	329	459	2015
MVHGT MVHGTX 125-4T/6-30 IE3	1470		41.00	23.80	22.00	98100	90	372	329	459	2015
MVHGT MVHGTX 125-4T/6-40 IE3	1480		57.10	33.10	30.00	117000	92	477	433	566	2015
MVHGT MVHGTX 125-4T/6-50 IE3	1480		69.20	40.10	37.00	123700	93	560	504	631	2015
MVHGT MVHGTX 125-4T/6-60 IE3	1475		80.90	46.90	45.00	136000	94	598	542	669	2015
MVHGT MVHGTX 125-4T/6-75 IE3	1480		98.60	57.20	55.00	148000	95	614	564	700	2015
MVHGT MVHGTX 125-4T/6-100 IE3	1485		134.00	77.70	75.00	161000	96	708	658	794	2015
MVHGT MVHGTX 125-4T/9-25 IE3	1470		35.10	20.30	18.50	79750	88	381	338	468	2015
MVHGT MVHGTX 125-4T/9-30 IE3	1470		41.00	23.80	22.00	97000	89	381	338	468	2015
MVHGT MVHGTX 125-4T/9-40 IE3	1480		57.10	33.10	30.00	111200	91	486	442	575	2015
MVHGT MVHGTX 125-4T/9-50 IE3	1480		69.20	40.10	37.00	118350	93	569	513	640	2015
MVHGT MVHGTX 125-4T/9-60 IE3	1475		80.90	46.90	45.00	127000	94	607	551	678	2015
MVHGT MVHGTX 125-4T/9-75 IE3	1480		98.60	57.20	55.00	142000	95	623	573	709	2015
MVHGT MVHGTX 125-4T/9-100 IE3	1485		134.00	77.70	75.00	155000	99	717	667	803	2015
MVHGT MVHGTX 125-6T/6-5.5 IE3	960	15.60	8.99		4.00	51300	77	216	183	347	2015
MVHGT MVHGTX 125-6T/6-7.5 IE3	970		11.20	6.49	5.50	60300	77	228	195	359	2015

Technical characteristics

Model	Speed (r/min)	Maximum admissible current (A)			Installed Power (kW)	Maximum flow rate (m³/h)	Sound pressure level dB(A)	Approx. weight (kg)			According ErP
		230 V	400 V	690 V				MVHGT Long	MVHGTX Short		
MVHGT MVHGTX 125-6T/6-10 IE3	975		14.80	8.58	7.50	72250	79	306	278	426	2015
MVHGT MVHGTX 125-6T/6-15 IE3	975		21.90	12.70	11.00	85450	81	307	279	427	2015
MVHGT MVHGTX 125-6T/6-20 IE3	975		28.20	16.30	15.00	92850	82	416	373	503	2015
MVHGT MVHGTX 125-6T/6-25 IE3	980		35.90	20.80	18.50	103000	84	449	405	538	2015
MVHGT MVHGTX 125-6T/9-10 IE3	975		14.80	8.58	7.50	68200	78	315	287	435	2015
MVHGT MVHGTX 125-6T/9-15 IE3	975		21.90	12.70	11.00	77550	81	316	288	436	2015
MVHGT MVHGTX 125-6T/9-20 IE3	975		28.20	16.30	15.00	92900	84	425	382	512	2015
MVHGT MVHGTX 125-6T/9-25 IE3	980		35.90	20.80	18.50	98700	85	458	414	547	2015
MVHGT MVHGTX 125-6T/9-30 IE3	980		42.40	24.60	22.00	104000	87	463	419	552	2015
MVHGT MVHGTX 125-8T/6-3	705	9.53	5.50		2.20	45700	69	218	185	349	2015
MVHGT MVHGTX 125-8T/6-4	705	12.82	7.40		3.00	51800	71	225	192	356	2015
MVHGT MVHGTX 125-8T/6-5.5	710	16.11	9.30		4.00	61500	72	258	230	378	2015
MVHGT MVHGTX 125-8T/6-7.5	710		12.00	7.20	5.50	67500	73	271	243	391	2015
MVHGT MVHGTX 125-8T/6-10	725		16.00	9.50	7.50	75500	75	301	273	421	2015
MVHGT MVHGTX 125-8T/9-4	705	12.82	7.40		3.00	48200	70	234	201	365	2015
MVHGT MVHGTX 125-8T/9-5.5	710	16.11	9.30		4.00	55200	73	267	239	387	2015
MVHGT MVHGTX 125-8T/9-7.5	710		12.00	7.20	5.50	67000	75	280	252	400	2015
MVHGT MVHGTX 125-8T/9-10	725		16.00	9.50	7.50	74750	76	310	282	430	2015
MVHGT MVHGTX 125-8T/9-15	720		24.00	13.80	11.00	80800	79	372	329	459	2015
MVHGT - 140-6T/6-5.5 IE3	960	15.60	8.99		4.00	58000	82	266	229		2015
MVHGT - 140-6T/6-7.5 IE3	970		11.20	6.49	5.50	66000	84	278	241		2015
MVHGT - 140-6T/6-10 IE3	975		14.80	8.58	7.50	80700	85	365	326		2015
MVHGT - 140-6T/6-15 IE3	975		21.90	12.70	11.00	96700	86	366	327		2015
MVHGT - 140-6T/6-20 IE3	975		28.20	16.30	15.00	104000	87	472	423		2015
MVHGT - 140-6T/6-25 IE3	980		35.90	20.80	18.50	115000	88	506	457		2015
MVHGT - 140-6T/6-30 IE3	980		42.40	24.60	22.00	119000	89	511	462		2015
MVHGT - 140-6T/9-10 IE3	975		14.80	8.58	7.50	70000	84	374	335		2015
MVHGT - 140-6T/9-15 IE3	975		21.90	12.70	11.00	86000	86	375	336		2015
MVHGT - 140-6T/9-20 IE3	975		28.20	16.30	15.00	97500	87	482	432		2015
MVHGT - 140-6T/9-25 IE3	980		35.90	20.80	18.50	111000	88	515	467		2015
MVHGT - 140-6T/9-30 IE3	980		42.40	24.60	22.00	118500	89	520	472		2015
MVHGT - 140-6T/9-40 IE3	985		55.40	32.10	30.00	132000	91	676	614		2015
MVHGT - 140-6T/9-50 IE3	985		67.20	39.00	37.00	139000	92	693	638		2015
MVHGT - 140-8T/6-3	705	9.53	5.50		2.20	47500	78	268	231		2015
MVHGT - 140-8T/6-4	705	12.82	7.40		3.00	57600	79	275	238		2015
MVHGT - 140-8T/6-5.5	710	16.11	9.30		4.00	65200	80	317	278		2015
MVHGT - 140-8T/6-7.5	710		12.00	7.20	5.50	73300	81	330	291		2015
MVHGT - 140-8T/6-10	725		16.00	9.50	7.50	82200	82	360	321		2015
MVHGT - 140-8T/6-15	720		24.00	13.80	11.00	94200	83	419	370		2015
MVHGT - 140-8T/9-4	705	12.82	7.40		3.00	47200	79	284	247		2015
MVHGT - 140-8T/9-5.5	710	16.11	9.30		4.00	64400	79	326	287		2015
MVHGT - 140-8T/9-7.5	710		12.00	7.20	5.50	69200	81	339	300		2015
MVHGT - 140-8T/9-10	725		16.00	9.50	7.50	78700	82	369	330		2015
MVHGT - 140-8T/9-15	720		24.00	13.80	11.00	94300	83	429	379		2015
MVHGT - 140-8T/9-20	725		31.00	18.10	15.00	103000	86	485	437		2015
MVHGT - 160-6T/6-10 IE3	975		14.80	8.58	7.50	75000	83	439	385		2015
MVHGT - 160-6T/6-15 IE3	975		21.90	12.70	11.00	93500	85	440	386		2015
MVHGT - 160-6T/6-20 IE3	975		28.20	16.30	15.00	120500	86	559	490		2015
MVHGT - 160-6T/6-25 IE3	980		35.90	20.80	18.50	130000	87	593	524		2015
MVHGT - 160-6T/6-30 IE3	980		42.40	24.60	22.00	140000	88	598	529		2015
MVHGT - 160-6T/6-40 IE3	985		55.40	32.10	30.00	158000	89	771	672		2015
MVHGT - 160-6T/6-50 IE3	985		67.20	39.00	37.00	171000	91	784	699		2015
MVHGT - 160-6T/9-15 IE3	975		21.90	12.70	11.00	87000	85	450	396		2015
MVHGT - 160-6T/9-20 IE3	975		28.20	16.30	15.00	104000	86	569	500		2015
MVHGT - 160-6T/9-25 IE3	980		35.90	20.80	18.50	127000	87	603	534		2015
MVHGT - 160-6T/9-30 IE3	980		42.40	24.60	22.00	135000	88	608	539		2015
MVHGT - 160-6T/9-40 IE3	985		55.40	32.10	30.00	147000	89	781	682		2015
MVHGT - 160-6T/9-50 IE3	985		67.20	39.00	37.00	165000	90	794	710		2015
MVHGT - 160-6T/9-60 IE3	985		84.40	48.90	45.00	177000	91	1019	920		2015
MVHGT - 160-6T/9-75 IE3	985		103.00	59.70	55.00	193000	92	1077	978		2015
MVHGT - 160-6T/9-100 IE3	990		139.00	80.60	75.00	207500	93	1232	1133		2015
MVHGT - 160-8T/6-4	705	12.82	7.40		3.00	70900	76	344	292		2015
MVHGT - 160-8T/6-5.5	710	16.11	9.30		4.00	84500	77	391	337		2015
MVHGT - 160-8T/6-7.5	710		12.00	7.20	5.50	77000	79	404	350		2015
MVHGT - 160-8T/6-10	725		16.00	9.50	7.50	95000	80	434	380		2015
MVHGT - 160-8T/6-15	720		24.00	13.80	11.00	109000	82	506	437		2015

Technical characteristics

Model	Speed (r/min)	Maximum admissible current (A)			Installed Power (kW)	Maximum flow rate (m³/h)	Sound pressure level dB(A)	Approx. weight (kg)		According ErP
		230 V	400 V	690 V				MVHGT Long	MVHGT Short	
MVHGT -	160-8T/6-20	725	31.00	18.10	15.00	123000	83	563	494	2015
MVHGT -	160-8T/6-25	725	36.00	20.70	18.50	130000	84	641	542	2015
MVHGT -	160-8T/9-7.5	710	12.00	7.20	5.50	70000	79	414	360	2015
MVHGT -	160-8T/9-10	725	16.00	9.50	7.50	87000	80	444	390	2015
MVHGT -	160-8T/9-15	720	24.00	13.80	11.00	103000	82	516	447	2015
MVHGT -	160-8T/9-20	725	31.00	18.10	15.00	117000	83	573	504	2015
MVHGT -	160-8T/9-25	725	36.00	20.70	18.50	133000	84	651	552	2015
MVHGT -	160-8T/9-30	725	42.00	24.40	22.00	140000	85	666	567	2015
MVHGT -	160-8T/9-40	730	61.00	35.10	30.00	151000	86	724	640	2015



Erp. (Energy Related Products)

Information on Directive 2009/125/EC : please consult with our technical department.

Acoustic characteristics

The indicated values are determined by measuring the pressure and sound power levels in dB(A) obtained in a free field at a distance equivalent to twice the size of the fan plus the impeller diameter, with a minimum of 1.5 m.

Sound power level Lw(A) in dB(A) per frequency band in Hz

Model	63	125	250	500	1000	2000	4000	8000	Model	63	125	250	500	1000	2000	4000	8000
125-4T/6-20	66	74	90	97	99	94	88	84	140-6T/9-25	70	88	97	96	95	91	82	77
125-4T/6-25	67	75	91	98	100	95	89	85	140-6T/9-30	70	88	97	96	95	91	82	77
125-4T/6-30	68	76	92	99	101	96	90	86	140-6T/9-40	71	89	98	97	96	92	83	78
125-4T/6-40	69	77	93	100	102	97	91	87	140-6T/9-50	74	92	101	100	99	95	86	81
125-4T/6-50	71	79	95	102	104	99	93	89	140-8T/6-3	61	73	82	86	84	78	68	65
125-4T/6-60	72	80	96	103	105	100	94	90	140-8T/6-4	63	75	84	88	86	80	70	67
125-4T/6-75	72	80	96	103	105	100	94	90	140-8T/6-5.5	64	76	85	89	87	81	71	68
125-4T/6-100	74	82	98	105	107	102	96	92	140-8T/6-7.5	65	77	86	90	88	82	72	69
125-4T/9-25	66	74	91	97	98	93	88	84	140-8T/6-10	66	78	87	91	89	83	73	70
125-4T/9-30	67	75	92	98	99	94	89	85	140-8T/6-15	68	80	89	93	91	85	75	72
125-4T/9-40	68	76	93	99	100	95	90	86	140-8T/9-4	61	72	83	88	86	82	72	67
125-4T/9-50	70	78	95	101	102	97	92	88	140-8T/9-5.5	62	73	84	89	87	83	73	68
125-4T/9-60	72	80	97	103	104	99	94	90	140-8T/9-7.5	63	74	85	90	88	84	74	69
125-4T/9-75	72	80	97	103	104	99	94	90	140-8T/9-10	64	75	86	91	89	85	75	70
125-4T/9-100	74	82	99	105	106	101	96	92	140-8T/9-15	65	76	87	92	90	86	76	71
125-6T/6-5.5	59	68	81	84	85	82	71	67	140-8T/9-20	67	78	89	94	92	88	78	73
125-6T/6-7.5	60	69	82	85	86	83	72	68	160-6T/6-10	67	82	91	93	90	84	76	72
125-6T/6-10	61	70	83	86	87	84	73	69	160-6T/6-15	68	83	92	94	91	85	77	73
125-6T/6-15	63	72	85	88	89	86	75	71	160-6T/6-20	70	85	94	96	93	87	79	75
125-6T/6-20	65	74	87	90	91	88	77	73	160-6T/6-25	71	86	95	97	94	88	80	76
125-6T/6-25	66	75	88	91	92	89	78	74	160-6T/6-30	71	86	95	97	94	88	80	76
125-6T/9-10	57	67	82	86	85	84	73	69	160-6T/6-40	72	87	96	98	95	89	81	77
125-6T/9-15	59	69	84	88	87	86	75	71	160-6T/6-50	74	89	98	100	97	91	83	79
125-6T/9-20	62	72	87	91	90	89	78	74	160-6T/9-15	67	85	94	93	92	88	79	74
125-6T/9-25	64	74	89	93	92	91	80	76	160-6T/9-20	68	86	95	94	93	89	80	75
125-6T/9-30	66	76	91	95	94	93	82	78	160-6T/9-25	69	87	96	95	94	90	81	76
125-8T/6-3	53	61	73	78	77	72	61	57	160-6T/9-30	70	88	97	96	95	91	82	77
125-8T/6-4	54	62	74	79	78	73	62	58	160-6T/9-40	71	89	98	97	96	92	83	78
125-8T/6-5.5	56	64	76	81	80	75	64	60	160-6T/9-50	72	90	99	98	97	93	84	79
125-8T/6-7.5	58	66	78	83	82	77	66	62	160-6T/9-60	72	90	99	98	97	93	84	79
125-8T/6-10	59	67	79	84	83	78	67	63	160-6T/9-75	73	91	100	99	98	94	85	80
125-8T/9-4	51	62	72	78	79	74	63	59	160-6T/9-100	75	93	102	101	100	96	87	82
125-8T/9-5.5	53	64	74	80	81	76	65	61	160-8T/6-4	60	75	84	86	83	77	69	65
125-8T/9-7.5	56	67	77	83	84	79	68	64	160-8T/6-5.5	61	76	85	87	84	78	70	66
125-8T/9-10	58	69	79	85	86	81	70	66	160-8T/6-7.5	62	77	86	88	85	79	71	67
125-8T/9-15	59	70	80	86	87	82	71	67	160-8T/6-10	63	78	87	89	86	80	72	68
140-6T/6-5.5	66	81	90	92	89	83	75	71	160-8T/6-15	65	80	89	91	88	82	74	70
140-6T/6-7.5	67	82	91	93	90	84	76	72	160-8T/6-20	66	81	90	92	89	83	75	71
140-6T/6-10	68	83	92	94	91	85	77	73	160-8T/6-25	68	83	92	94	91	85	77	73
140-6T/6-15	69	84	93	95	92	86	78	74	160-8T/9-7.5	60	78	87	86	85	81	72	67
140-6T/6-20	71	86	95	97	94	88	80	76	160-8T/9-10	62	80	89	88	87	83	74	69
140-6T/6-25	72	87	96	98	95	89	81	77	160-8T/9-15	63	81	90	89	88	84	75	70
140-6T/6-30	73	88	97	99	96	90	82	78	160-8T/9-20	64	82	91	90	89	85	76	71
140-6T/9-10	66	84	93	92	91	87	78	73	160-8T/9-25	65	83	92	91	90	86	77	72
140-6T/9-15	67	85	94	93	92	88	79	74	160-8T/9-30	66	84	93	92	91	87	78	73
140-6T/9-20	69	87	96	95	94	90	81	76	160-8T/9-40	68	86	95	94	93	89	80	75

Accessories

See accessories section.





Dimensions mm

MVHGT

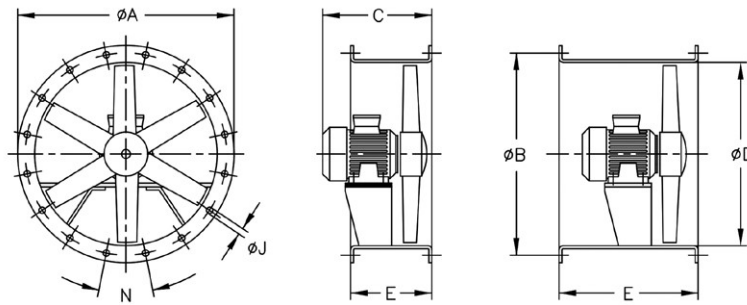

Model	ØA	ØB	C (Consult motor construction size)							ØD	E*		ØJ	N
			132	160	180	200	225	250	280		Short (STD)	long		
MVHGT-125	1365	1320	586	-	-	-	-	-	-	1250	500	700	15	20x18°
MVHGT-125	1365	1320	-	700	-	-	-	-	-	1250	500	700	15	20x18°
MVHGT-125	1365	1320	-	-	765	825	-	-	-	1250	700	900	15	20x18°
MVHGT-125	1365	1320	-	-	-	-	910	-	-	1250	700	1000	15	20x18°
MVHGT-125	1365	1320	-	-	-	-	-	985	-	1250	700	1000	15	20x18°
MVHGT-125	1365	1320	-	-	-	-	-	-	1190	1250	700	1200	15	20x18°
MVHGT-140	1515	1470	586	-	-	-	-	-	-	1400	400	650	15	20x18°
MVHGT-140	1515	1470	-	700	-	-	-	-	-	1400	450	700	15	20x18°
MVHGT-140	1515	1470	-	-	765	825	-	-	-	1400	550	900	15	20x18°
MVHGT-140	1515	1470	-	-	-	-	910	-	-	1400	550	1000	15	20x18°
MVHGT-140	1515	1470	-	-	-	-	-	985	-	1400	600	1000	15	20x18°
MVHGT-160	1735	1680	586	-	-	-	-	-	-	1600	400	650	19	24x15°
MVHGT-160	1735	1680	-	700	-	-	-	-	-	1600	450	700	19	24x15°
MVHGT-160	1735	1680	-	-	765	825	-	-	-	1600	550	900	19	24x15°
MVHGT-160	1735	1680	-	-	-	-	910	-	-	1600	550	1000	19	24x15°
MVHGT-160	1735	1680	-	-	-	-	-	985	-	1600	600	1000	19	24x15°
MVHGT-160	1735	1680	-	-	-	-	-	-	1190	1600	700	1200	19	24x15°

*Standard version supplied with short casing. Long casing with inspection hatch available on request.

Motor construction sizes depending on power

Poles	r/min	CV	3	4	5.5	7.5	10	15	20	25	30	40	50	60	75	100
4T	1500	-	-	-	-	-	132	160	160	180	180	200	225	225	250	280
6T	1000	-	132	132	132	160	160	160	180	200	200	225	250	280	280	280
8T	750	-	132	132	160	160	160	180	200	225	225	250	-	-	-	-

MVHGT-X

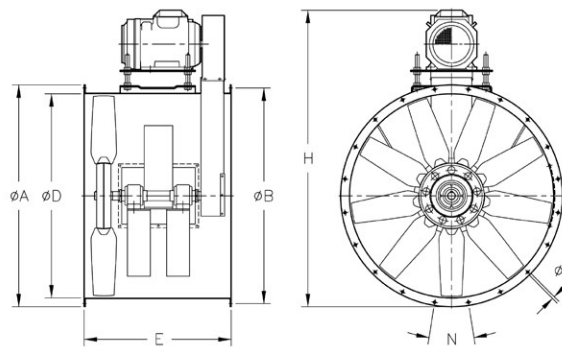

Model	ØA	ØB	ØD	E	H (Consult motor construction size)							ØJ	N	
					132	160	180	200	225	250	280			
MVHGT-X 125	1365	1320	1250	900	1743	1815	1850	-	-	-	-	-	15	20x18°
MVHGT-X 125	1365	1320	1250	960	-	-	-	1930	1995	-	-	-	15	20x18°
MVHGT-X 125	1365	1320	1250	1100	-	-	-	-	-	2060	-	-	15	20x18°
MVHGT-X 125	1365	1320	1250	1100	-	-	-	-	-	-	2090	-	15	20x18°

Motor construction sizes depending on power

Poles	r/min	CV	3	4	5.5	7.5	10	15	20	25	30	40	50	60	75	100
4T	1500	-	-	-	-	-	132	160	160	180	180	200	225	225	250	280
6T	1000	-	132	132	132	160	160	160	180	200	200	225	250	280	280	280
8T	750	-	132	132	160	160	160	180	200	225	225	250	-	-	-	-

SELECTION EXAMPLE

Characteristic curves

Q = Flow rate in m³/h, m³/s and cfm.

Pe = Static pressure in mm H₂O, Pa and inwg.

Impeller diameter (cm): 125 Number of poles: 8 Number of blades: 6

MVHGT MVHGTX

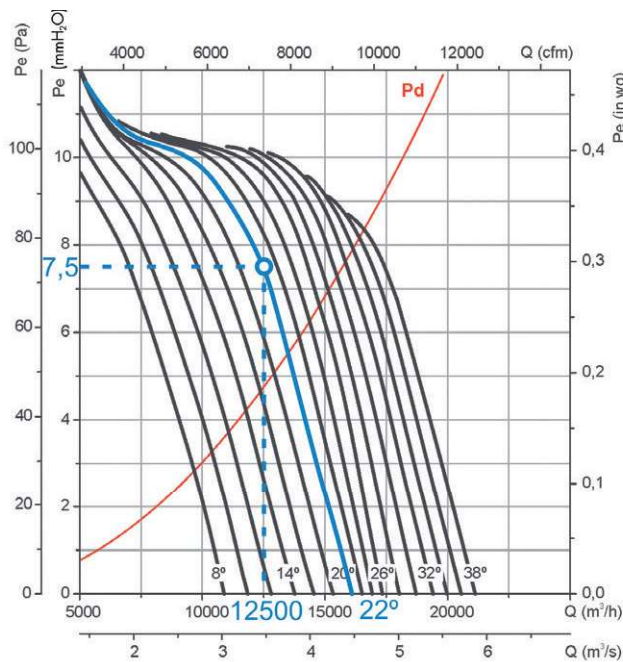

Starting data

Working point:

- Flow rate: 12,500 m³/h
- Load loss: 7.5 mm H₂O

Equipment selection steps

On the pressure graph:

1. Mark the working point defined by the working flow rate (12,500 m³/h) and the load loss (7.5 mm H₂O).
2. Select the nearest equipment curve above the working point. In this case, a blade angle curve of 22° is obtained.

On the power graph:

3. Mark the working point defined by the working flow rate (12,500 m³/h) and the selected blade angle curve (22°).
4. Read the absorbed power on the left power axis. Pa = 560 W at the working point.
5. Find the nearest straight red line above the working point. The installed motor power is given on the right side of the graph. In this case, 0.75 kW or 1 HP

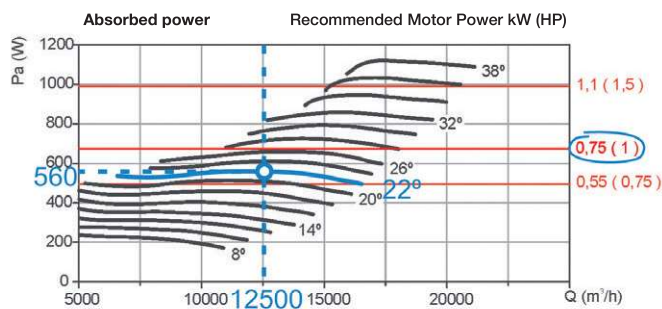

ORDER CODE EXAMPLE

MVHGT — 125 — 8T — 6 — 1 — 22

MVHGT: Large diameter cased axial fans with direct drive motors
MVHGTX: Large diameter cased axial fans with external motors

Impeller diameter in cm

Number of motor poles
4 = 1400 r/min 50 Hz
6 = 900 r/min 50 Hz
8 = 750 r/min 50 Hz

T = Three-phase
M = Single-phase

Number of blades
6 blades
9 blades

Motor power (HP)

Blade inclination angle



Characteristic curves

Q = Flow rate in m³/h, m³/s and cfm.

Pe = Static pressure in mm H₂O, Pa and inwg.

Impeller diameter (cm): 125

Number of poles: 4

Number of blades: 6

MVHGT MVHGTX

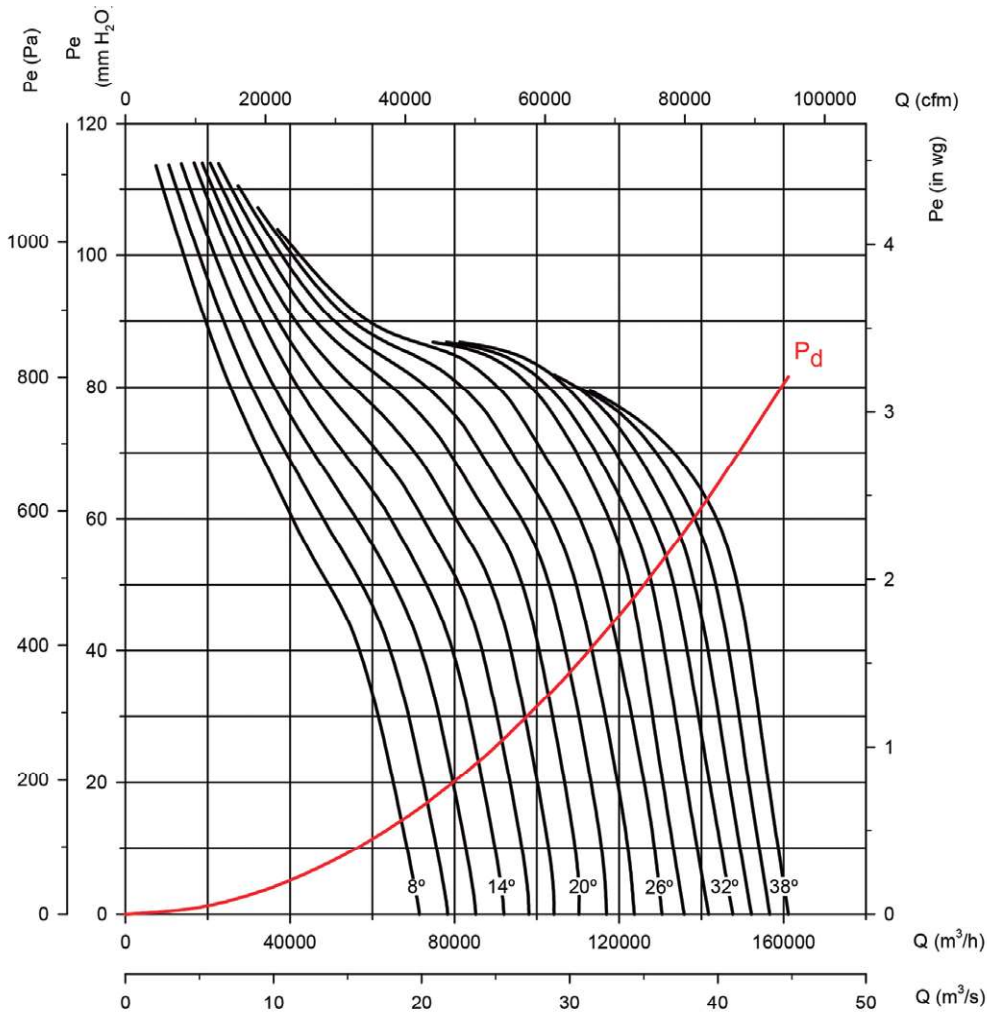

Absorbed power

Recommended Motor Power kW (HP)

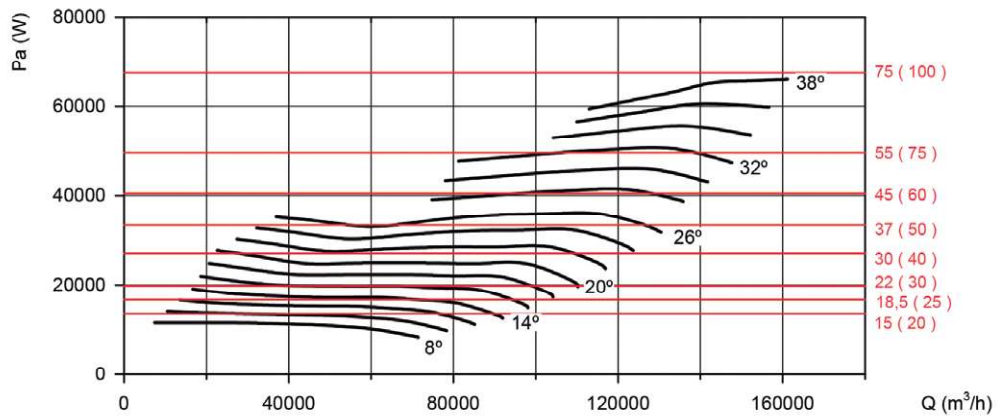

Characteristic curves

Q = Flow rate in m³/h, m³/s and cfm.

Pe = Static pressure in mm H₂O, Pa and inwg.

Impeller diameter (cm): 125

Number of poles: 4

Number of blades: 9

MVHGT MVHGTX

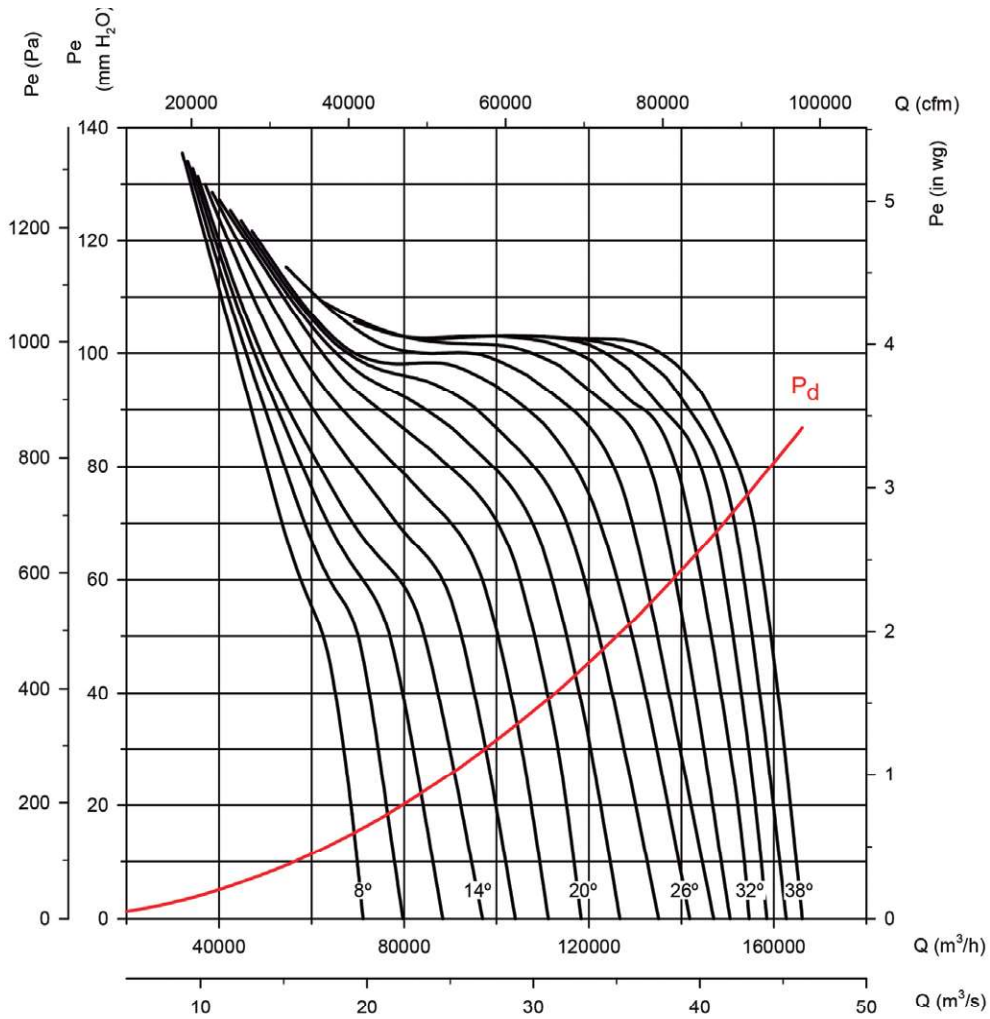

Absorbed power

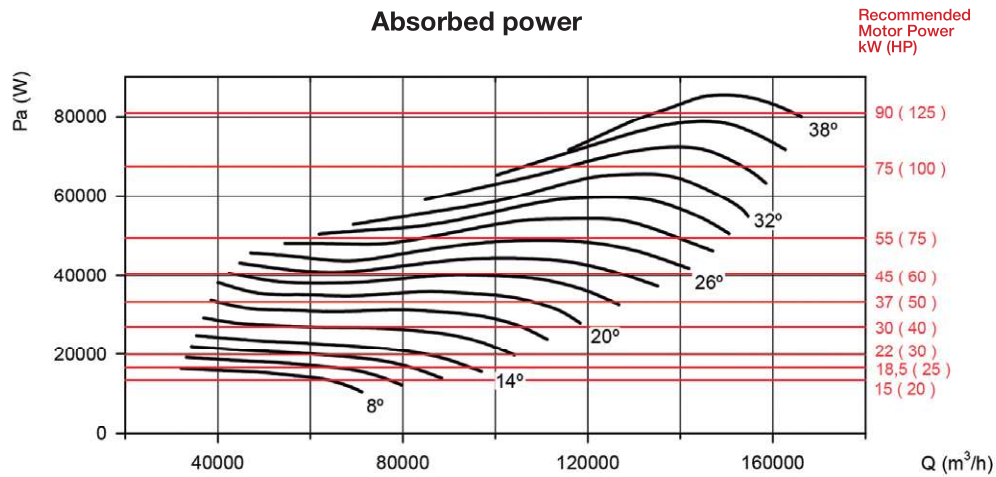



Characteristic curves

Q = Flow rate in m³/h, m³/s and cfm.

Pe = Static pressure in mm H₂O, Pa and inwg.

Impeller diameter (cm): 125

Number of poles: 6

Number of blades: 6

MVHGT MVHGTX

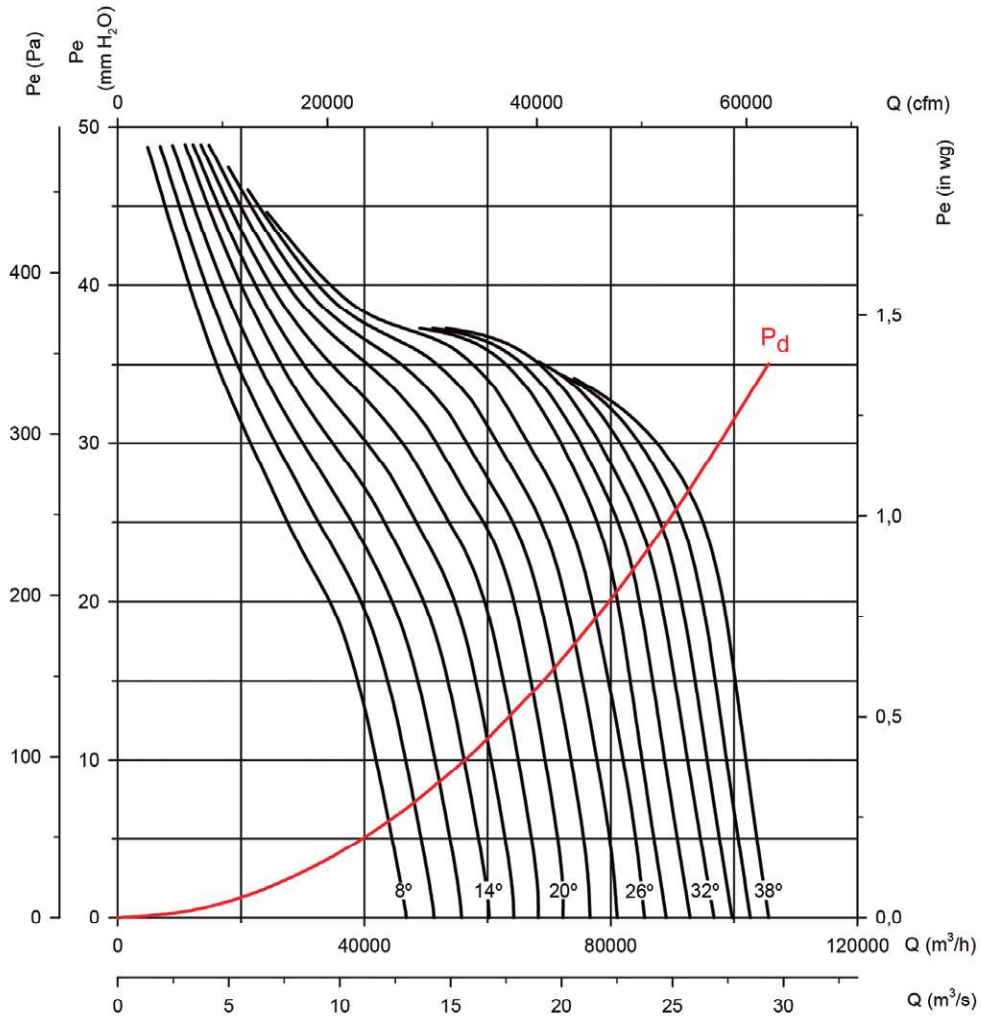

Absorbed power

Recommended Motor Power kW (HP)

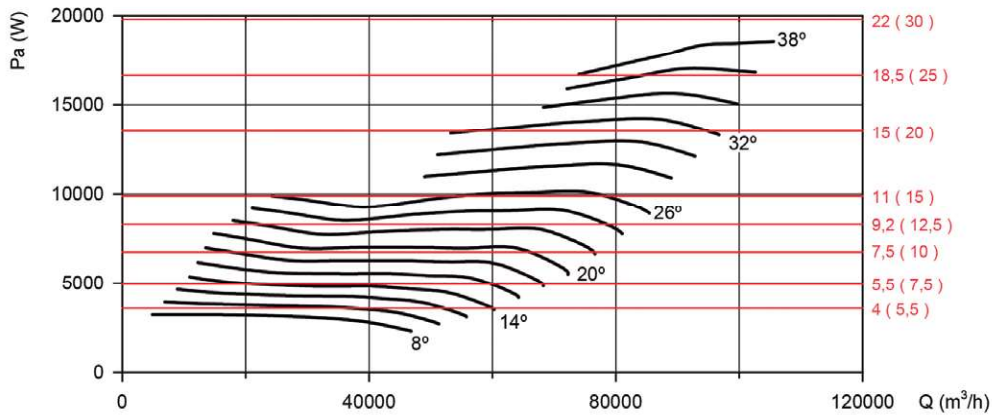

Characteristic curves

Q = Flow rate in m³/h, m³/s and cfm.

Pe = Static pressure in mm H₂O, Pa and inwg.

Impeller diameter (cm): 125

Number of poles: 6

Number of blades: 9

MVHGT MVHGTX

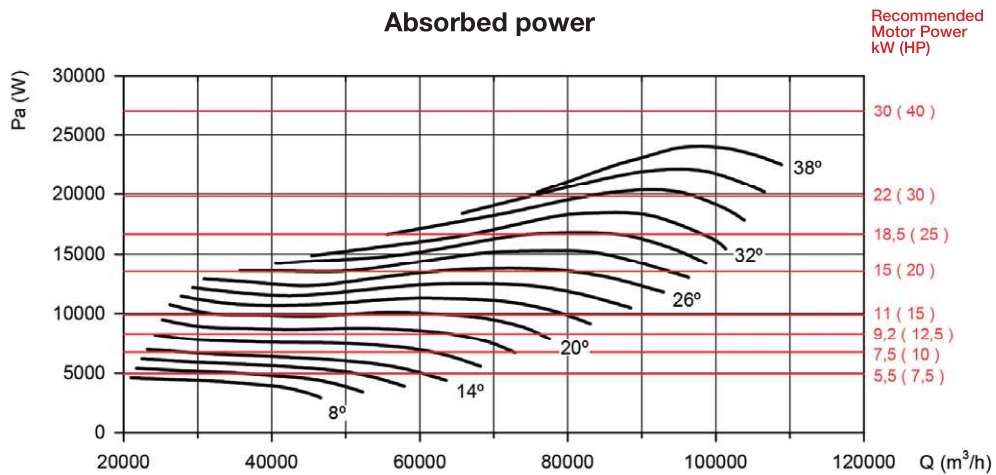
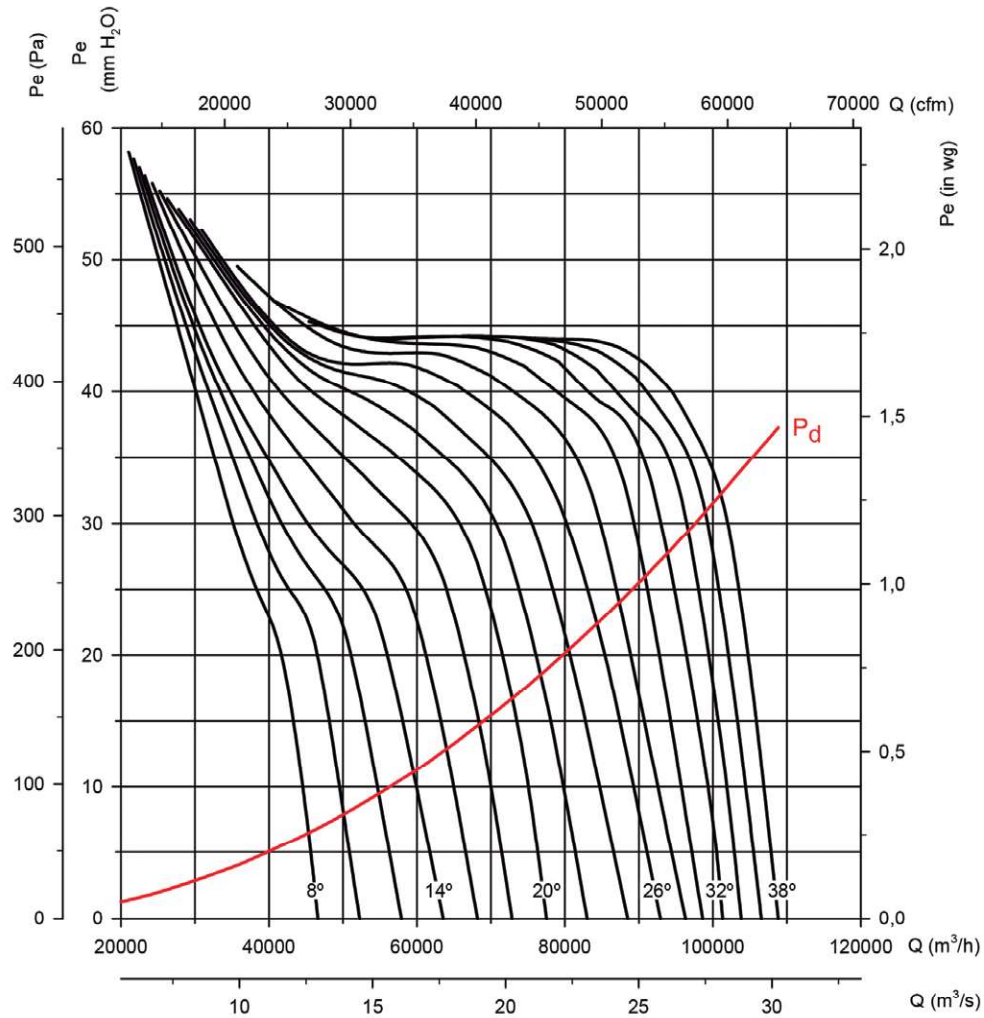



Characteristic curves

Q = Flow rate in m³/h, m³/s and cfm.

Pe = Static pressure in mm H₂O, Pa and inwg.

Impeller diameter (cm): 125

Number of poles: 8

Number of blades: 6

MVHGT MVHGTX

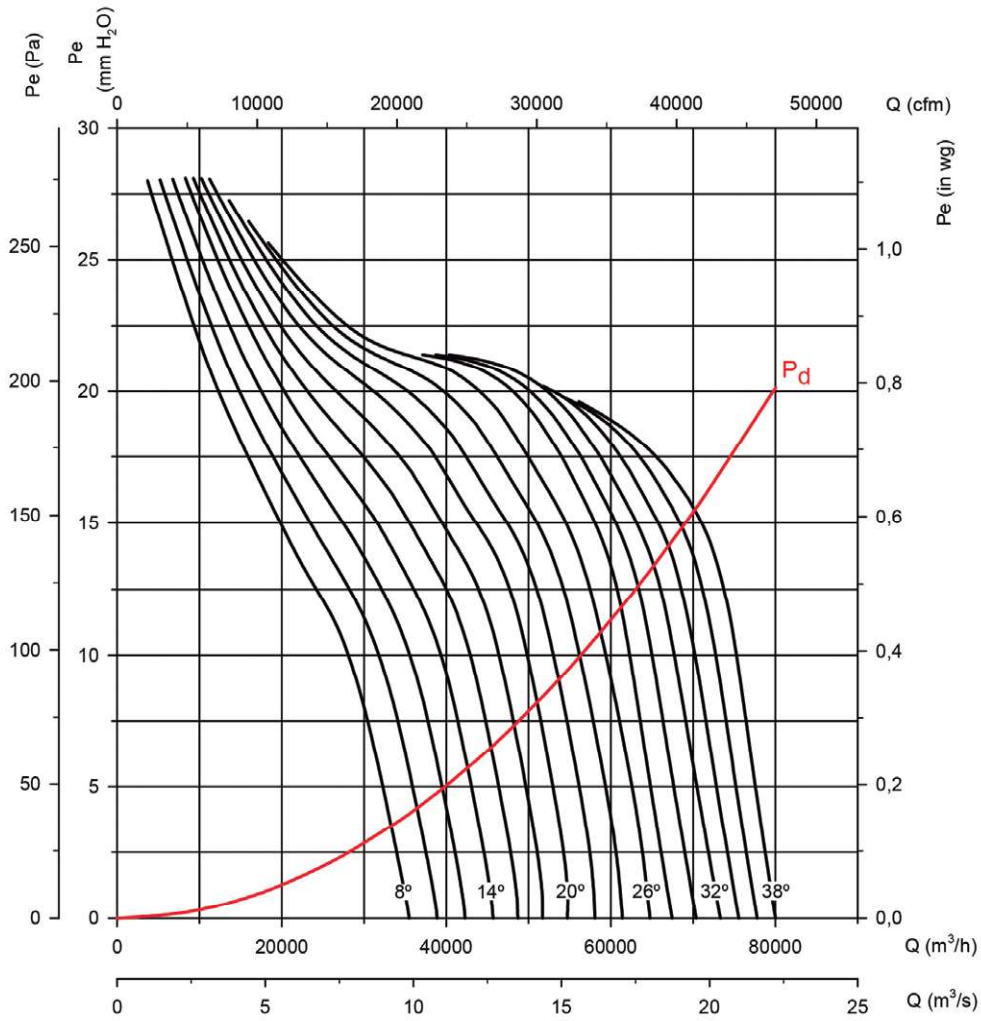

Absorbed power

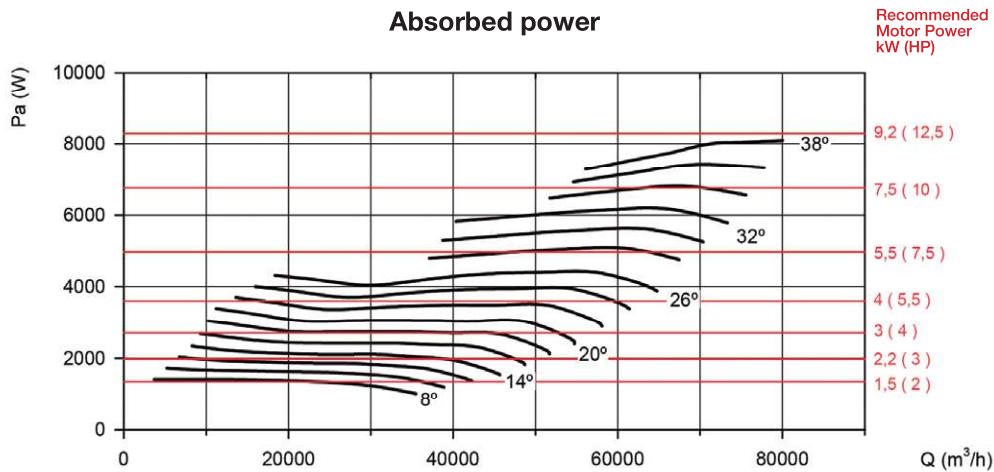

Characteristic curves

Q = Flow rate in m³/h, m³/s and cfm.

Pe = Static pressure in mm H₂O, Pa and inwg.

Impeller diameter (cm): 125

Number of poles: 8

Number of blades: 9

MVHGT MVHGTX

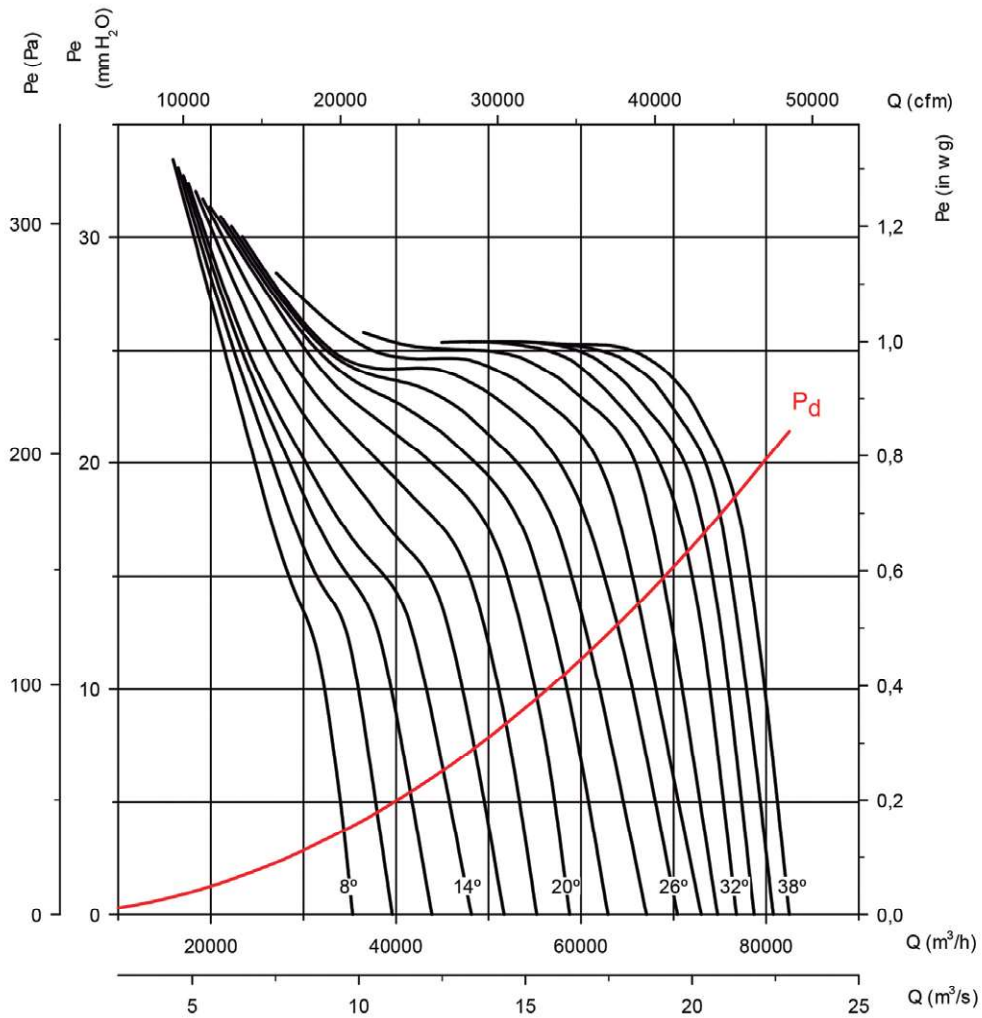

Absorbed power

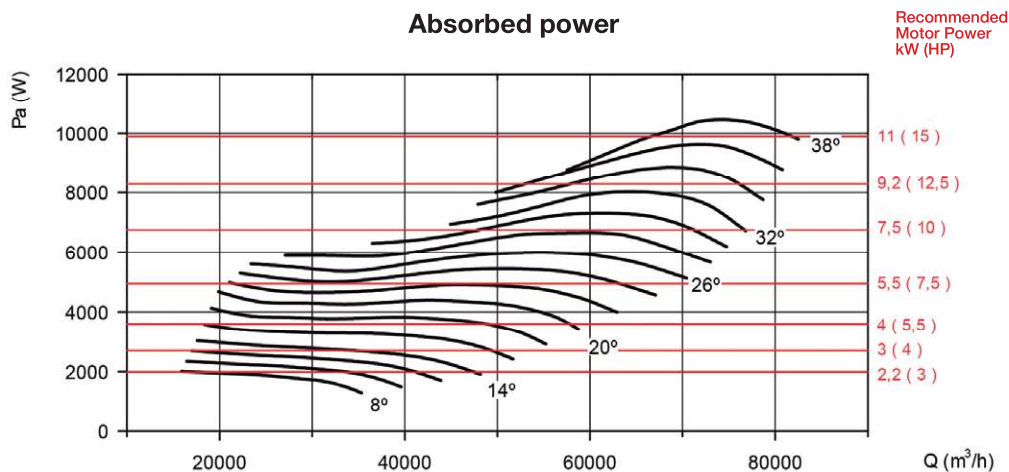



Characteristic curves

Q = Flow rate in m³/h, m³/s and cfm.

Pe = Static pressure in mm H₂O, Pa and inwg.

Impeller diameter (cm): 140

Number of poles: 6

Number of blades: 6

MVHGT MVHGTX

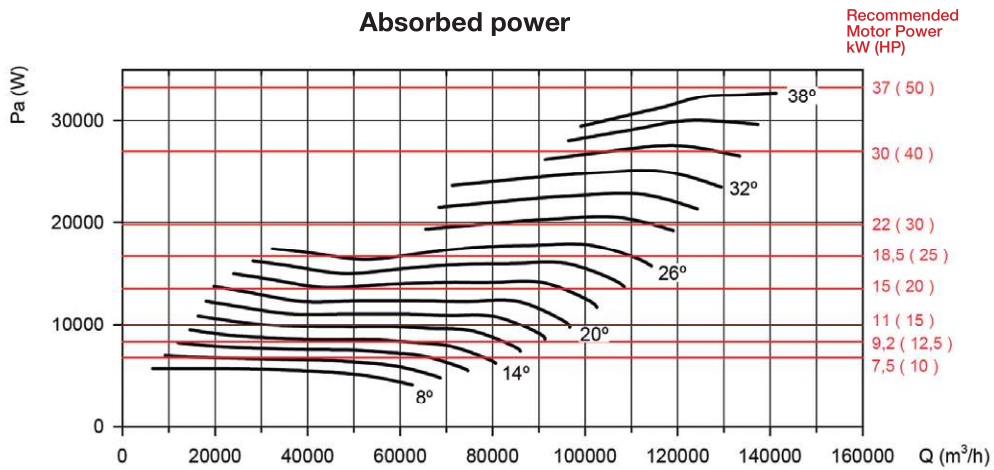
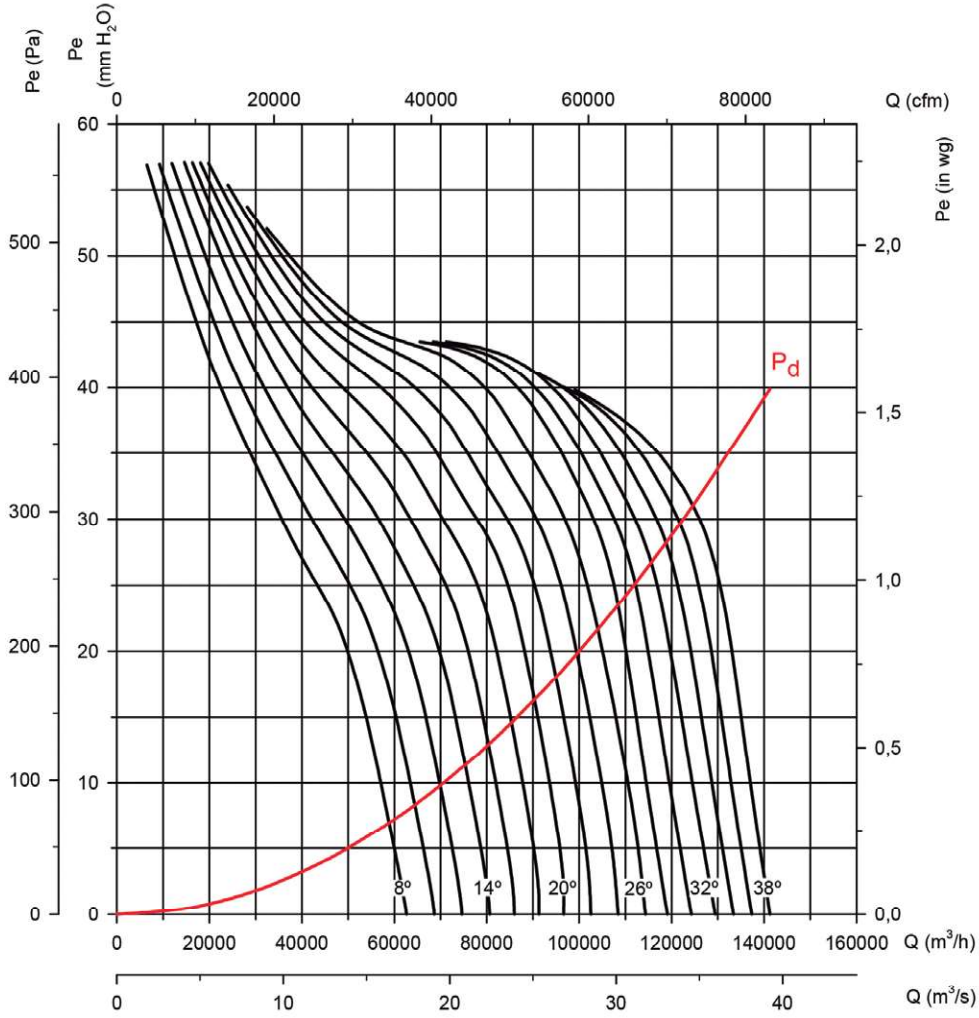

Characteristic curves

Q = Flow rate in m³/h, m³/s and cfm.

Pe = Static pressure in mm H₂O, Pa and inwg.

Impeller diameter (cm): 140

Number of poles: 6

Number of blades: 9

MVHGT MVHGTX

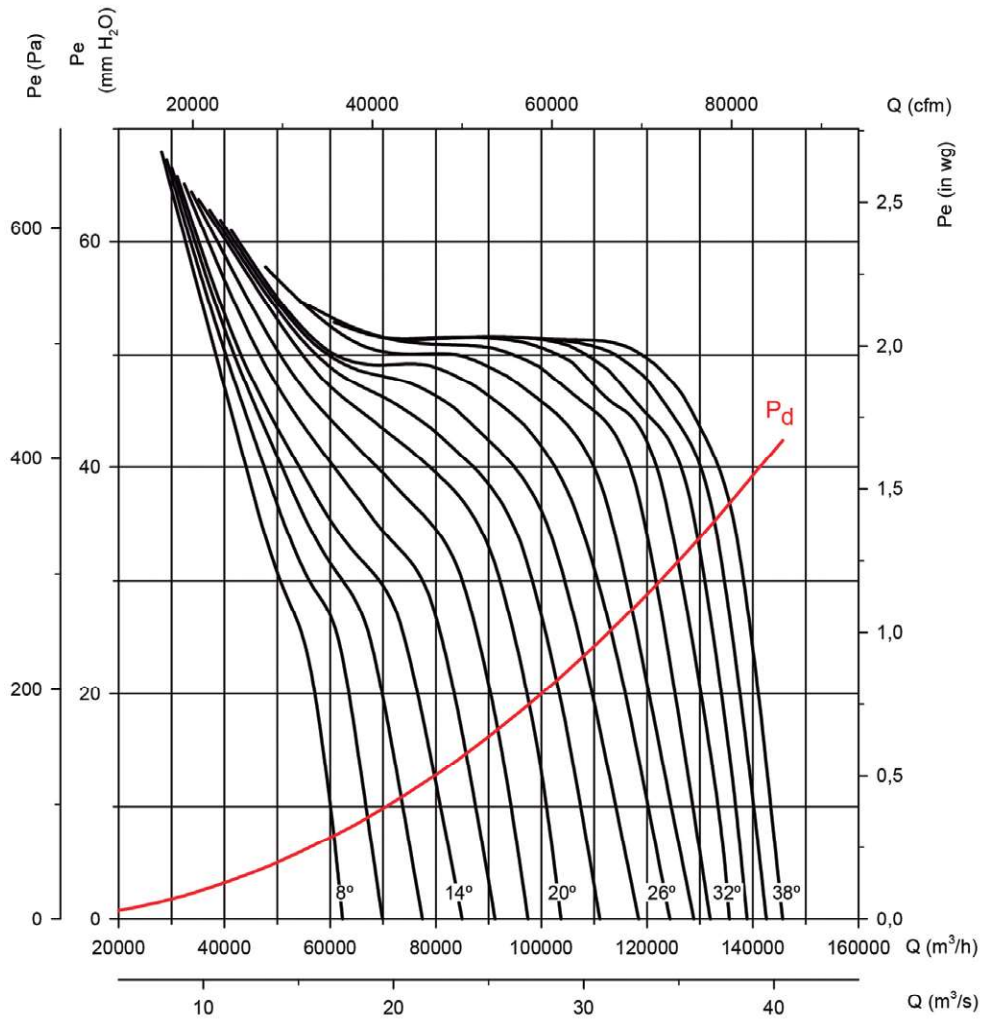

Absorbed power

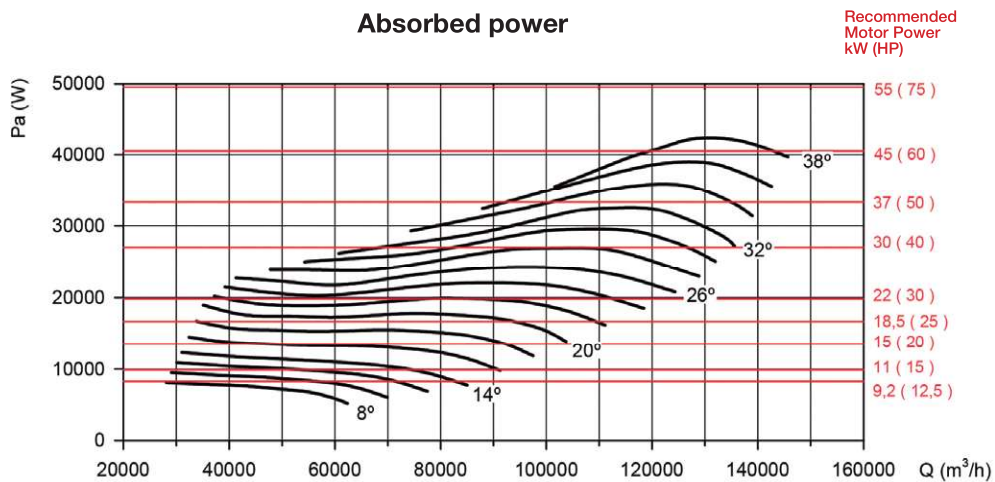



Characteristic curves

Q = Flow rate in m³/h, m³/s and cfm.

Pe = Static pressure in mm H₂O, Pa and inwg.

Impeller diameter (cm): 140

Number of poles: 8

Number of blades: 6

MVHGT MVHGTX

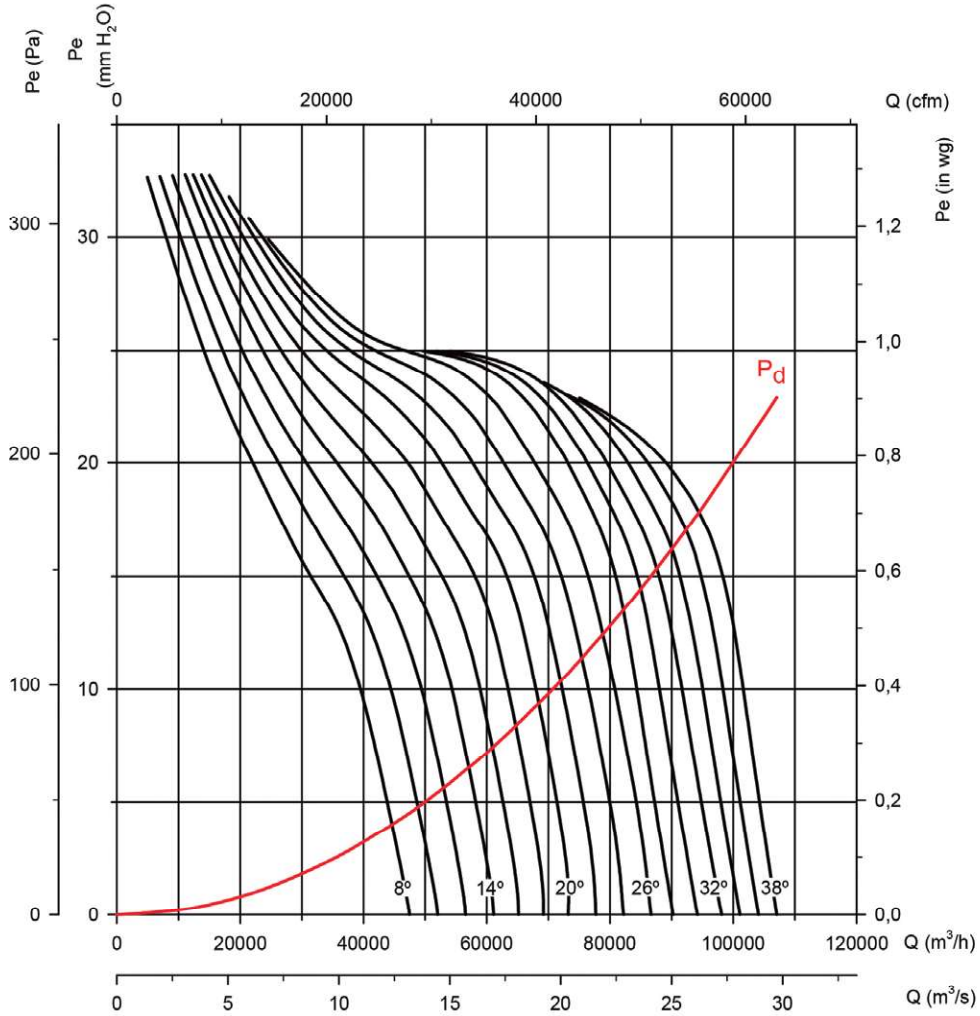

Absorbed power

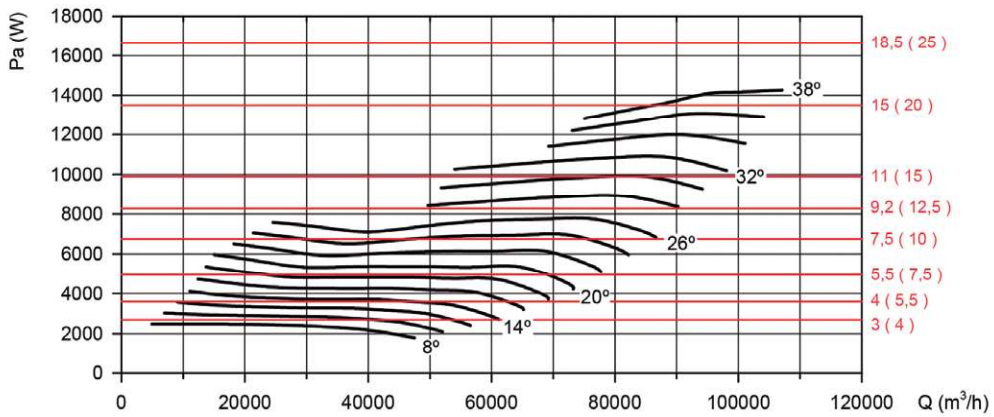

Characteristic curves

Q = Flow rate in m³/h, m³/s and cfm.

Pe = Static pressure in mm H₂O, Pa and inwg.

Impeller diameter (cm): 140

Number of poles: 8

Number of blades: 9

MVHGT MVHGTx

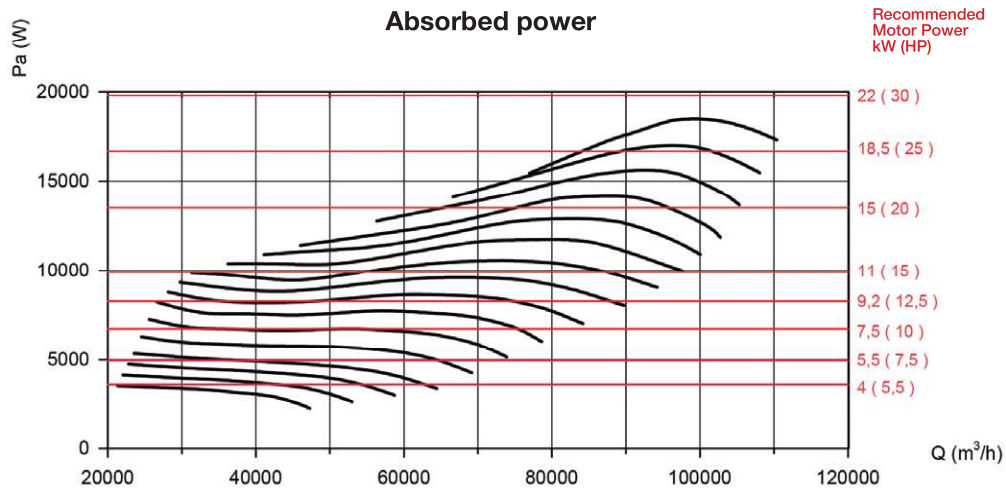
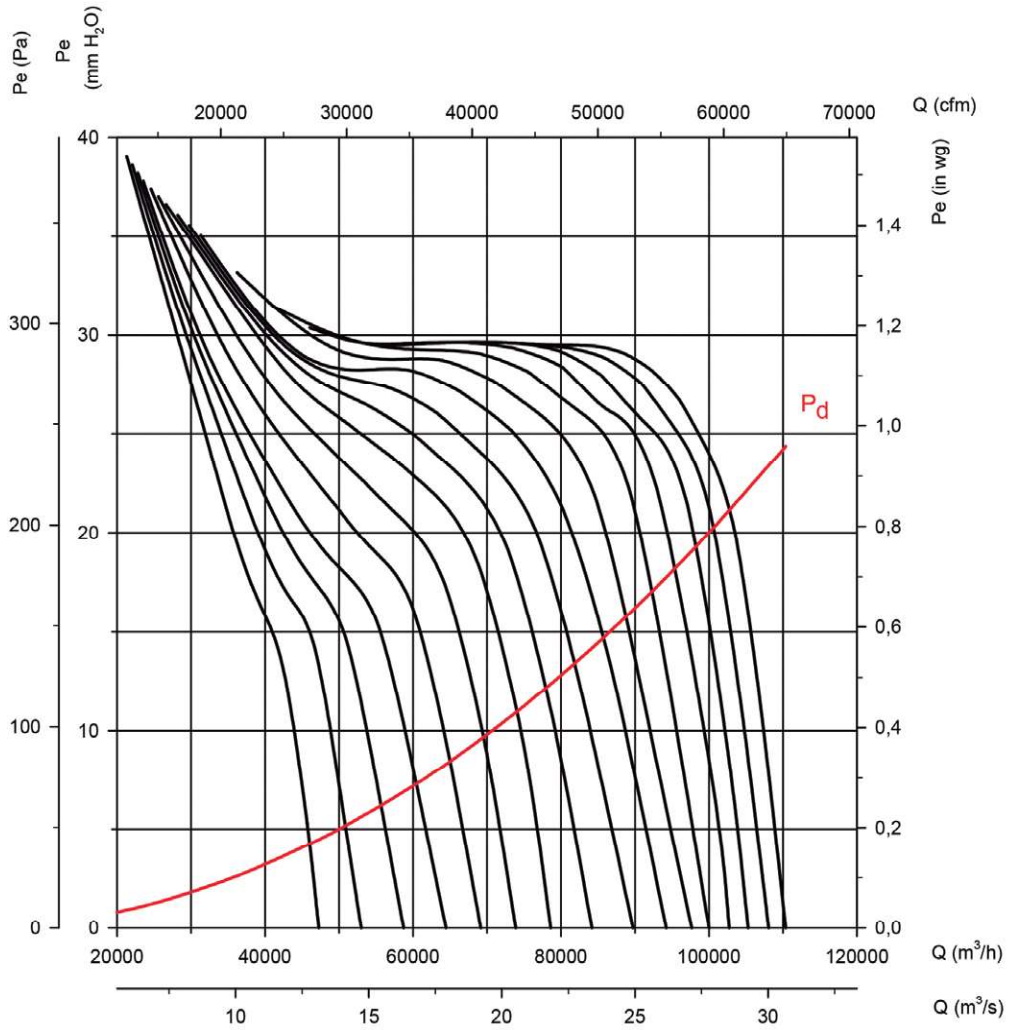



Characteristic curves

Q = Flow rate in m³/h, m³/s and cfm.

Pe = Static pressure in mm H₂O, Pa and inwg.

Impeller diameter (cm): 160

Number of poles: 6

Number of blades: 6

MVHGT MVHGTX

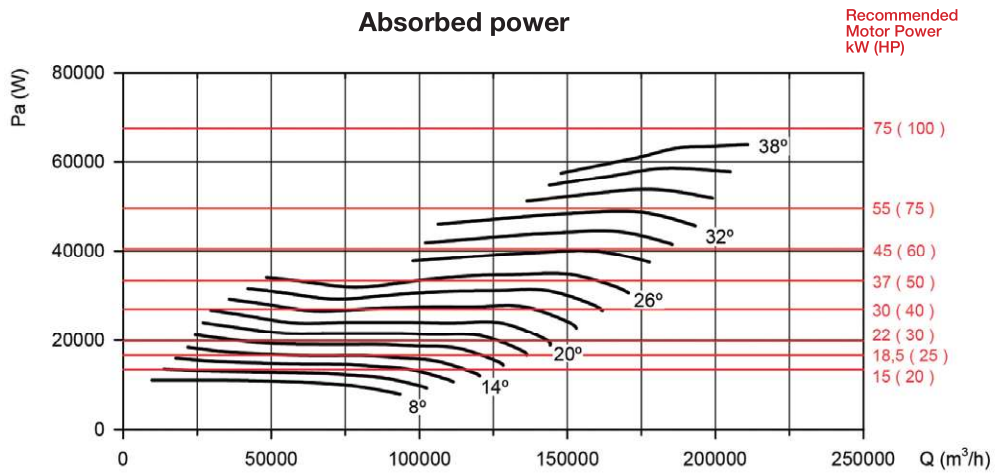
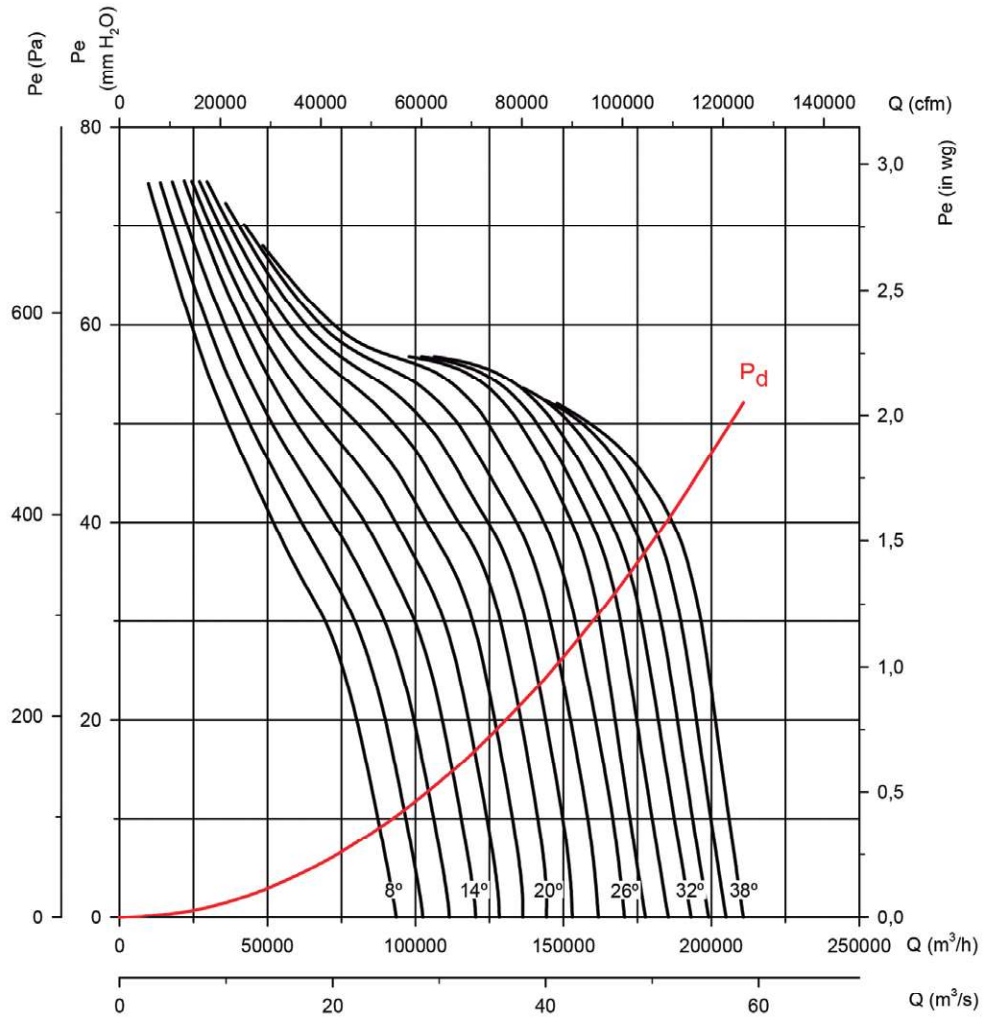

Characteristic curves

Q = Flow rate in m³/h, m³/s and cfm.

Pe = Static pressure in mm H₂O, Pa and inwg.

Impeller diameter (cm): 160

Number of poles: 6

Number of blades: 9

MVHGT MVHGTX

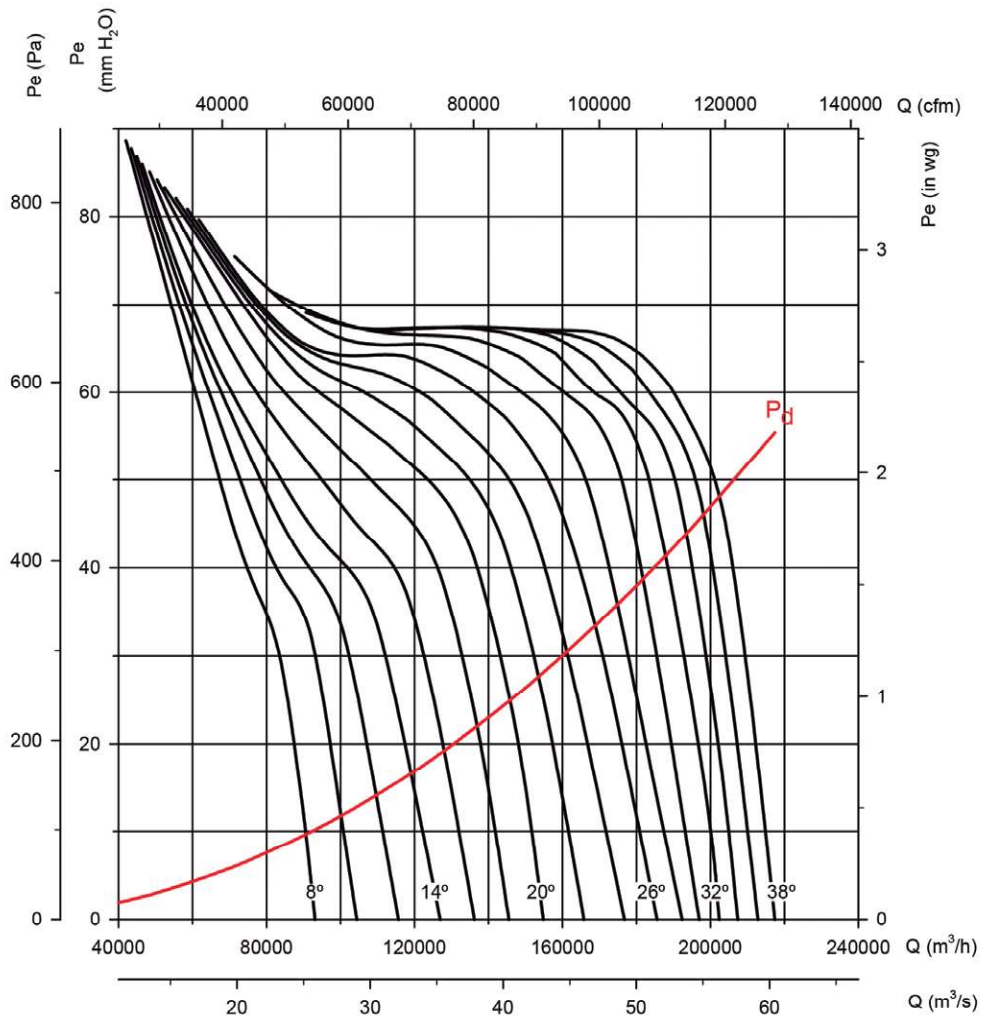

Absorbed power

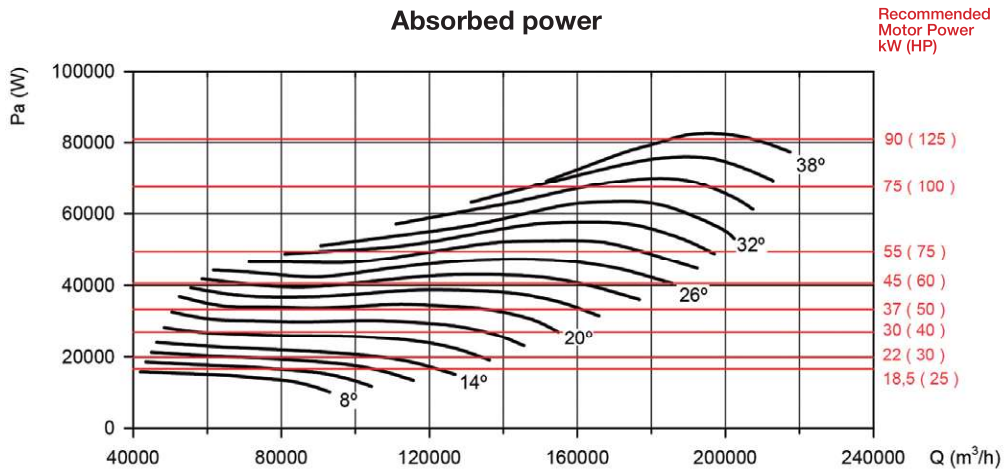



Characteristic curves

Q = Flow rate in m³/h, m³/s and cfm.

Pe = Static pressure in mm H₂O, Pa and inwg.

Impeller diameter (cm): 160

Number of poles: 8

Number of blades: 6

MVHGT MVHGTX

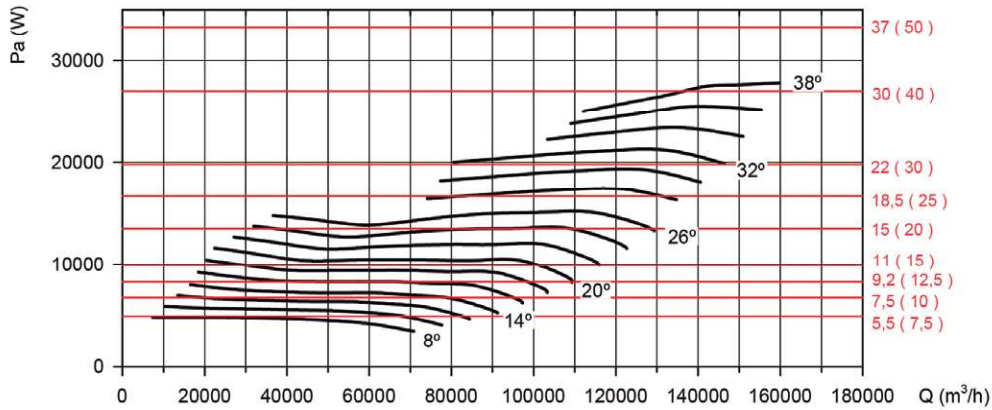
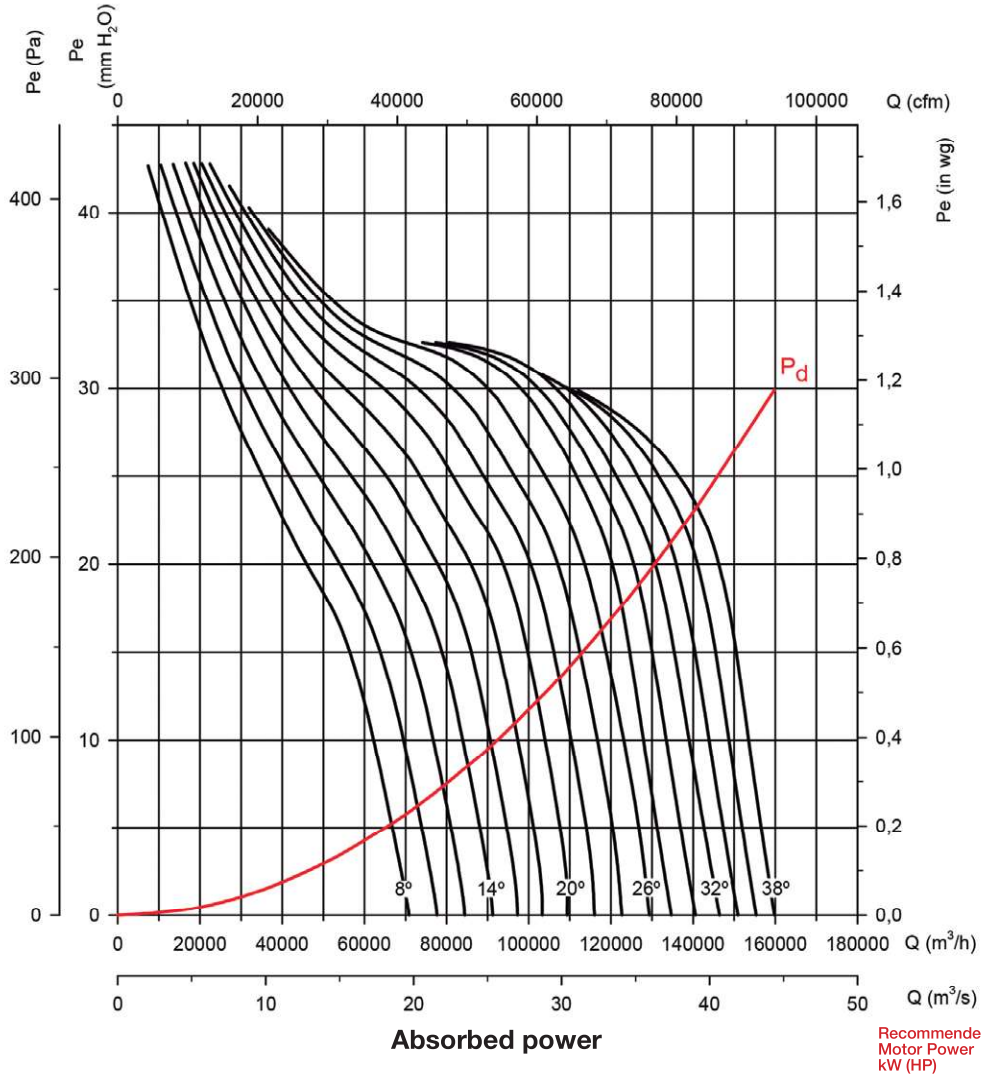

Characteristic curves

Q = Flow rate in m³/h, m³/s and cfm.

Pe = Static pressure in mm H₂O, Pa and inwg.

Impeller diameter (cm): 160

Number of poles: 8

Number of blades: 9

MVHGT MVHGTX

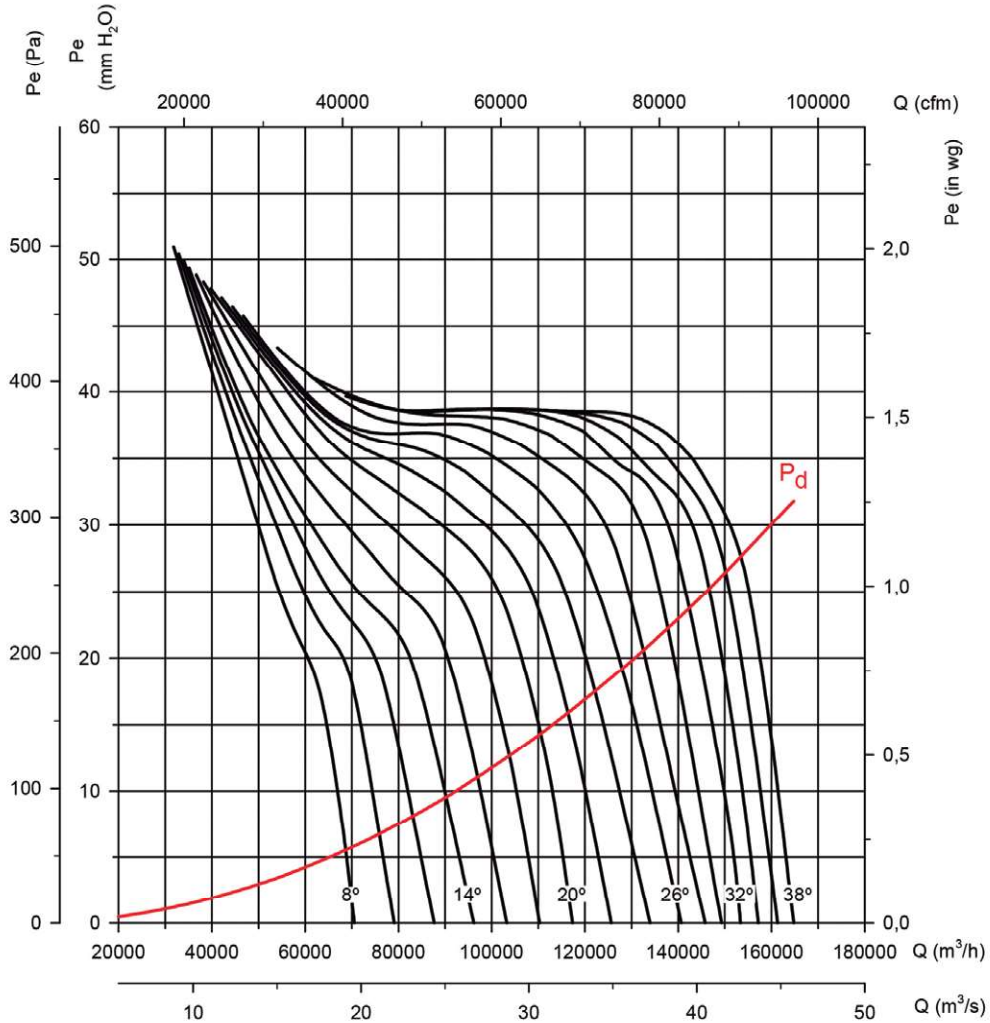

Absorbed power

