



SMART EVO 2 - User Manual

ELECTRICAL PANEL FOR 2 MOTORS

CONTENTS

1.	INTRODUCTION	5
2.	WARNINGS	6
3.	GENERAL DESCRIPTION	7
4.	INSTALLATION	8
5.	LUMINOUS INDICATORS AND COMMANDS	9
6.	INPUTS AND OUTPUTS	10
7.	ANTI-SEIZING FUNCTION	12
8.	DIP-SWITCH SETTINGS	13
8.1	<i>DIP-SWITCH 1 - Level alarm activated by level probes</i>	13
8.2	<i>DIP-SWITCH 2 - Thermal cut-out activation delay 5/10 seconds</i>	13
8.3	<i>DIP-SWITCH 3 - Alarm output</i>	14
8.4	<i>DIP-SWITCH 4 - Enable motor's clicson to reset alarm</i>	14
8.5	<i>DIP-SWITCH 5 - Emptying/filling operation</i>	14
8.6	<i>DIP-SWITCH 6 - Start /stop function (Start/stop floats switch)</i>	15
8.7	<i>DIP-SWITCH 7 - Enabled of delayed board activation on power mains return</i>	15
8.8	<i>DIP-SWITCH 8 - Switching module enable</i>	16
9.	TRIMMER SETTINGS	17
9.1	<i>TRIMMER SENS. PROBE - Probe sensitivity</i>	17
9.2	<i>TRIMMER MIN - Activation on minimum current</i>	17
9.3	<i>TRIMMER MAX - Activation on current overload</i>	18
10.	BOARD SPECIFICATIONS	19
11.	STANDARD CIRCUIT DIAGRAMS	20
11.1	<i>SMART EVO 2 Single phase (230V) circuit diagram</i>	20
11.2	<i>SMART EVO 2 Three phase (400V) circuit diagram</i>	21
12.	STANDARD WIRING DIAGRAMS	22
12.1	<i>SMART EVO 2 Single phase (230V) wiring diagram</i>	22
12.2	<i>SMART EVO 2 Three phase (400V) wiring diagram</i>	22
13.	APPLICATION AND INSTALLATION EXAMPLES	23

- 14. **STANDARD DIMENSIONAL DIAGRAM 24**
 - 14.1 *SMART EVO 2 Single phase dimensional 24*
 - 14.2 *SMART EVO 2 Three phase 7.5 dimensional..... 24*
- 15. **TROUBLESHOOTING 25**

1. INTRODUCTION

This manual must always accompany the relevant equipment and be conserved in an accessible location for consultation by qualified technicians assigned for operation and maintenance of the system.

The installer/user is strongly recommended to carefully read all instructions and information in this manual before using the product, in order to avoid damage or improper use of the unit, which would also render the warranty null and void.

Before operating the equipment, carefully read the manual and follow all instructions provided.

The information and instructions in this manual refer to the standard use of this product; in the event of special circumstances, functions or applications not described in this document, contact our service center for assistance.

If technical assistance or spare parts are required, when contacting the manufacturer always specify the identification code of the model and construction number as stated on the data plate.

Our service center is available for any requirement or clarification.

On receipt of the goods, inspect immediately to ensure that the equipment has not been damaged during transport. If defects are found, the client should promptly notify our retailer within 5 days of receiving the goods, or in the event of direct purchases, the producer service center.



N.B. the information provided in this manual is subject to modifications without notice. The manufacturer shall not be held liable for any damage caused in relation to the use of these instructions, as they are to be considered guideline only. Note that failure to observe the instructions provided in this manual may cause physical injury or damage to objects.

In any event all local and/or current legislation must be observed at all times.

2. WARNINGS



The electrical panel must be used exclusively for the purpose and function as specified in design. Any other application or use is to be considered improper and therefore hazardous.

In the event of a fire in the place of installation or the surrounding area, avoid the use of water jets and use the appropriate extinguishing equipment and means (powder, foam, carbon dioxide).

Install the equipment far from heat sources and in a dry and sheltered location in observance of the stated protection rating (IP).

The installation of a safety device is recommended to protect the panel power line in compliance with current electrical standards.

The electrical panel must be connected by a qualified electrician in observance of the relevant electrical standards.

No parts of the panel must be disassembled without the official authorization of the producer: any tampering with or modifications to the unit will render all terms of the warranty null and void.

All installation and/or maintenance operations must be performed by a specialized technician who is fully aware of the relevant current safety standards.

Ensure the installation is connected to an efficient earthing system.

After making the electrical connection, check that all electrical panel settings are correct to avoid automatic start-up of the electric pump.

The producer declines all liability in the event of the following:

- Incorrect installation;
- Use by personnel not adequately trained in the correct use of the panel;
- Serious failure to perform scheduled maintenance;
- Use of non-original spare parts or parts not specific to the model;
- Unauthorized modifications or interventions;
- Partial or total failure to observe instructions.

3. GENERAL DESCRIPTION

- Single phase power supply 100-240Vac 50/60Hz (SMART EVO 2-Mono);
- Three phase power supply 100-240Vac or 310-450Vac 50/60Hz (SMART EVO 2 -Tri);
- G/P1 and G/P2 normally open inputs for start-up command;
- 3 inputs for single-pole level sensors (C-MIN-MAX);
- T1 and T2 inputs for motor clicson;
- GA normally open input for alarm activation;
- AUTOMATIC-O-MANUAL buttons (spring return);
- DIP-SWITCH 1 level alarm enabled by probes;
- DIP-SWITCH 2 thermal cut-out activation delay: 5/10 seconds;
- DIP-SWITCH 3 alarm output settings;
- DIP-SWITCH 4 enable motor clicson alarm reset;
- DIP-SWITCH 5 for filling/emptying mode;
- DIP-SWITCH 6 start/stop float enable;
- DIP-SWITCH 7 enable of delay on board activation on power mains return;
- DIP-SWITCH 8 motor switching module enable;
- Green led: power ON / failure or incorrect phase sequence
- 2 green leds: automatic mode enabled;
- Green led: motor active;
- Red led: level alarm from sensors or GA input;
- 2 Red leds: motor overload alarm/minimum current alarm;
- 2 red leds: motor clicson activation alarm;
- Electronic control of maximum current due to overload, with assisted calibration;
- Electronic control of minimum current due to dry run, with assisted calibration;
- Automatic reset due to minimum current alarm;
- Protections of aux. circuits and motor with fuses;
- Cumulative alarm output with voltage-free contacts (NC-C-NO resistive load - 5A / 250V);
- Cumulative alarm output, live (12Vcc / 100mA);
- Door lock general disconnect switch;
- Provision for start-up capacitors, single phase version (not included);
- Box in ABS, IP55;
- Ambient temperature: -5/+40 °C;
- Relative humidity 50% at 40 °C (condensate free).

4. INSTALLATION

Ensure that the mains power supply specifications correspond to the voltage specified on the data plate of the electrical panel and motor connected, then make the earthing connection before all other connections.

SMART EVO 2-Mono	▶	1~100-240Vac 50/60Hz
SMART EVO 2-Tri	▶	3~100-240Vac o 3~310-450Vac 50/60Hz

The power line must be protected by a residual current circuit breaker.

Tighten the electrical cables on the relative terminals using a suitable tool correctly sized to avoid the risk of damage to the fixing screws. Take care if using an electric screwdriver.

The electrical panel is designed for wall-mounting using screws and plugs in the pre-drilled holes at the corners of the enclosure, or by means of brackets when present.

Install the equipment in areas compliant with the protection rating and ensure that the box is kept intact when drilling the holes for fitting the cable clamps.

Avoid the use of multicore cables where there are wires connected to inductive loads and power cables and signal cables such as sensors and digital inputs.

Keep connection cables as short as possible, preventing any twisting of cables which may be harmful due to inductive effects on the electronic equipment.

All wires used in the cabling must be suitably sized to withstand the load to be powered.

5. LUMINOUS INDICATORS AND COMMANDS



STEADY green led mains power ON

FLASHING green led failure or incorrect phase sequence

Green led OFF device not powered;

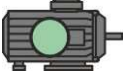

STEADY green led electric pump operating

QUICK FLASHING green led (1 second) minimum current control enabled

Green led OFF electric pump on standby



STEADY red led motor thermal cut-out trip

SLOW FLASHING red led minimum current alarm

QUICK FLASHING red led (1 second) minimum current control disabled



STEADY red led level alarm from sensor input

FLASHING red led alarm from GA input



STEADY red led motor temperature overload alarm with manual reset

FLASHING red led motor temperature overload alarm with automatic reset

AUT button automatic mode

AUT button for alarm reset (when pressed for 2 seconds)



STEADY green led automatic mode active

SLOW FLASHING green led motor current calibration mode (Min/Max)

Green led OFF automatic mode disabled



0 button motor operation stop or standby



MAN button manual mode

6. INPUTS AND OUTPUTS

T1	Normally open input for motor clicson (over temperature thermoswitch)
-----------	---

T2	Normally open input for motor clicson 2 (over temperature thermoswitch)
-----------	---

C - MIN - MAX	Inputs for level probes or minimum level float switch (connection between C and MAX) Jumper them if only G/P1 is used and DIP-SWITCH 5 is ON
----------------------	---

G/P1	Normally open input for motor activation by start pressure switch or float switch. Jumper if only input C-MIN-MAX is used.
-------------	---

G/P2	Normally open input for alarm activation. With rotation function active: at each input it will start both motors regardless of G/P1 status.
-------------	--

G.A.	Normally open input for alarm activation
-------------	--

OUT ALARM (NC - C - NO)	Volt free contacts cumulative alarm output (resistive load 5A - 250V) for: <ul style="list-style-type: none">- Probe level alarm (selectable dip switch 1)- Input alarm GA- Motor overcurrent alarm- Minimum motor current alarm- Motor overheating alarm
------------------------------------	---

BUZZ +/-	Energized alarm output 12Vcc - 100mA
-----------------	--------------------------------------

SINGLE-PHASE:

- L/S - Motor 1 phase
- N/R - Motor 1 neutral
- AVV - Start by capacitor in the panel

OUT MOTOR 1

THREE-PHASE:

- T1 (contactor) - Motor's 1 phase U
- T2 (contactor) - Motor's 1 phase V
- T3 (contactor) - Motor's 1 phase W

SINGLE-PHASE:

- L/S - Motor 2 phase
- N/R - Motor 2 neutral
- AVV - Start by capacitor in the panel

OUT MOTOR 2

THREE-PHASE:

- T1 (contactor) - Motor's 2 phase U
- T2 (contactor) - Motor's 2 phase V
- T3 (contactor) - Motor's 2 phase W



Earth

7. ANTI-SEIZING FUNCTION

A pump auto-test can be set only if the control panel is in Automatic operation.

The auto-test has a fix time not adjustable and it will enable the pump or the pumps, according to the model of the panel, for 2 seconds every 48 hours.

To activate the anti-seizing function switch the panel on keeping the buttons “0” + “AUT” of the motor pressed. The green led of the motor will show the activation.

To deactivate the anti-seizing function switch the panel on keeping the buttons “0” + “AUT” of the motor pressed. The green led of the motor will show the activation.

To check if the function is active: when switching on the panel the green led of the motor with a fix light for a second while the other leds are blinking means that the auto-test is active.

If the auto-test is disabled all the led lights are blinking.



N.B.: Please note that every time the panel is switched off or the function is disabled the counting of the time will start from zero.

8. DIP-SWITCH SETTINGS

Set DIP-SWITCHES with the control panel switched off.

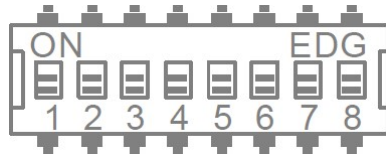

8.1 DIP-SWITCH 1 - Level alarm activated by level probes

OFF ↓ Level alarm activated by level probes disabled.

ON ↑ Level alarm activated by level probes enabled

DIP-SWITCH 1 allows to enable the level alarm activated by level probes or minimum level floating (input C-MIN-MAX).

In OFF position the change of status of the input contact does not involve any alarm signal.

In ON position the change of status of the input contact according to emptying or filling function allows the alarm signal on the panel and the activation of the volt free contact alarm output and the energized alarm output.

8.2 DIP-SWITCH 2 - Thermal cut-out activation delay 5/10 seconds

OFF ↓ 5 seconds thermal cut-out activation delay.

ON ↑ 10 seconds thermal cut-out activation delay.

The DIP-SWITCH 2 enables the selection of the thermal cut-out activation delay for 5 or 10 seconds.

The settings of this parameter prevents activation of the overload thermal cut-out during motor start-up, thereby avoiding a start-up current.

In OFF position the thermal cut-out activation delay is 5 seconds.

In ON position the thermal cut-out activation delay is 10 seconds.

8.3 DIP-SWITCH 3 - Alarm output

OFF ↓	In case of any tripped alarm, the output relay and 12 Vdc output are activated.
ON ↑	In case of any tripped alarm the output relays are activated. In case of GA alarm the output relay and 12 Vdc output are activated.

DIP-SWITCH 3 enables separation of the voltage-free contact alarm and 12 Vdc output.

In OFF position for any alarm voltage-free contact alarm and 12 Vdc output are activated.

In ON position for any alarm voltage-free alarm is activated (not the 12 Vdc output)

For GA input voltage-free alarm and 12 Vdc output are activated.

8.4 DIP-SWITCH 4 - Enable motor's clicson to reset alarm

OFF ↓	Motor overtemperature alarm with manual reset.
ON ↑	Motor overtemperature overload alarm with automatic reset.

DIP-SWITCH 4 enables the selection of the manual or automatic reset of the motor's overtemperature alarm activated by the T1 and T2 clicson input. The manual rest is done by keeping the AUT button pressed.

In OFF position the reset of the overtemperature alarm is manual.

In ON position the delay on thermal protection is 10 seconds.

8.5 DIP-SWITCH 5 - Emptying/filling operation

OFF ↓	Level probes operation in filling mode only
ON ↑	Level probes operation in emptying or pressurization mode only

DIP-SWITCH 5 enables selection of whether to use the sensor inputs COM-MIN-MAX in emptying or filling mode.

In OFF position (filling) the input will be used to enable the sistem in lack of water situation. C-MIN-MAX input to be enabled must be open. In case of switch on/off mode (floating) use C-MIN-MAX input.

In ON position (emptying or pressurization) the input will be used to enable the sistem in water presence situation. To enable the sistem the C-MIN-MAX sistem must be closed. In case of switch on/off mode (floating) use C-MIN-MAX input.

NB: Make a bridge on C-MAX when not using a minimum level control.

8.6 DIP-SWITCH 6 - Start /stop function (Start/stop floats switch)

OFF ↓	Sewage start/stop function disabled (start/stop floats switch)
ON ↑	Sewage start/stop function enabled (start/stop floats switch)

DIP-SWITCH 6 allows to start the start/stop function of float switches, for sewage applications.

To use the panel with this setting you must connect the stop float to C-MAX input and the start float to G/P1.

In OFF position start/stop float switches function is disabled.

In ON position the start/stop float switches function is enabled.

NB: Do not enable on pressurization systems. Enable emptying mode only when C-MIN-MAX input is used with floats or level probes.

8.7 DIP-SWITCH 7 - Enabled of delayed board activation on power mains return

OFF ↓	Disable of delay on board activation after power supply failure.
ON ↑	Delayed board activation on power supply failure.

DIP-SWITCH 7 enables the delay on board activation in the event of lack of mains power supply. On return of power the board enables the inputs and outputs after 30 seconds delay.

In OFF position the control panel will start immediately on power return.

In ON position the control panel will start after 30 seconds from power return.

N.B: after a power supply failure the control panel will start with the same AUT-0-MAN mode previously set up.

8.8 DIP-SWITCH 8 - Switching module enable

OFF ↓	Switching module disable.
ON ↑	Switching module enable.

DIP-SWITCH 8 enables automatic switching of the motors.

When enabled, this function means that on each call from input G/P1 the motor outputs are activated alternately and, in the event of a call from input G/P2 at the same time, both motors will be operated.

When enabled, the switching module alternates the motor on each call from input G/P1 and also switches motors in the event of:

- **current overload of a motor**
- **motor set to standby**
- **Lack of water on subsequent automatic reset**

If direct control of the motors is required, deactivate the switching module so that G/P1 directly and independently controls the output of motor 1 and G/P2 directly and independently controls the output of motor 2.

9. TRIMMER SETTINGS

9.1 TRIMMER SENS. PROBE - Probe sensitivity

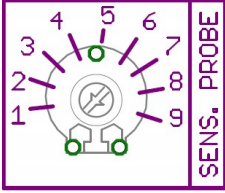

The trimmer “SENS. PROBE” can be used to adjust sensitivity of the sensors to adapt them to conductivity of the liquid. This value should therefore be increased in the case of liquids with low conductivity.

9.2 TRIMMER MIN - Activation on minimum current

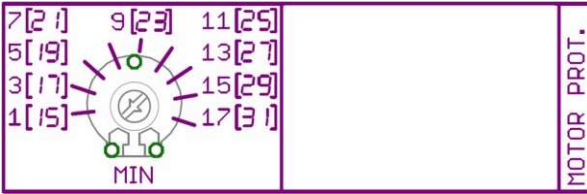

The “MIN” trimmer enables adjustment of the minimum motor current for protection against the risk of dry running, for added protection or when minimum level floats or sensors are not required.

When enabled, this parameter enables automatic reactivation if no water is present, with automatic reset every 2 minutes on the first 15 attempts, and then repeated attempts every 5 minutes.

To access assisted calibration mode, press and hold the button “0” of motor 1 during power-up of the panel, and the green led on the “AUT” button will start to flash.

Start up the motor using the “MAN” button and rotate the trimmer clockwise (starting from 1A), until the green led indicating pump operation turns on.

Control can be disabled by rotating the trimmer to the min value in case the C-MIN-MAX input is used with probes or float switch.

On deactivation, the red led indicating motor thermal cut-out starts flashing quickly for 1 second.



N.B. To calibrate the minimum current, the motor must be started up with water present.

9.3 TRIMMER MAX - Activation on current overload

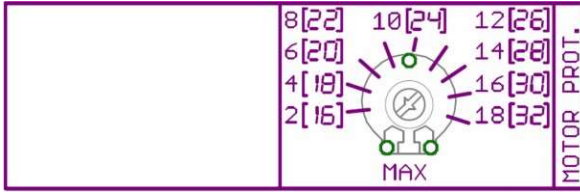

The "MAX" trimmer enables adjustment of the maximum motor current, over which the system protection trips due to current overload.

The maximum current can be adjusted in two ways:

- Nominal motor current.
- Automatic calibration.

9.3.1 *Nominal motor current*

If the nominal motor current is known, set a value higher by approx. 15%, according to the screen printing of the board.

9.3.2 *Automatic calibration*

Press and hold the button "0" of motor 1 during power-up of the panel, and the green led on the "AUT" button will start to flash.

Start up the motor using the "MAN" button and rotate the trimmer clockwise (starting from 2A), until the red thermal cut-out led turns on.

When lit, the red led indicates that the set current is 15% higher than the current absorbed by the motor.



N.B. To calibrate the maximum current, the motor must be started up with water present.

The current scale is proportional to the power of the control panel:
1 to 18 Ampere or 15 to 32 Ampere.

CAUTION!

Always calibrate the trimmer in observance of the maximum current specified on the electrical panel.

Exceeding the maximum specified threshold will automatically render the warranty null and void.



10. BOARD SPECIFICATIONS



11. STANDARD CIRCUIT DIAGRAMS

11.1 SMART EVO 2 Single phase (230V) circuit diagram

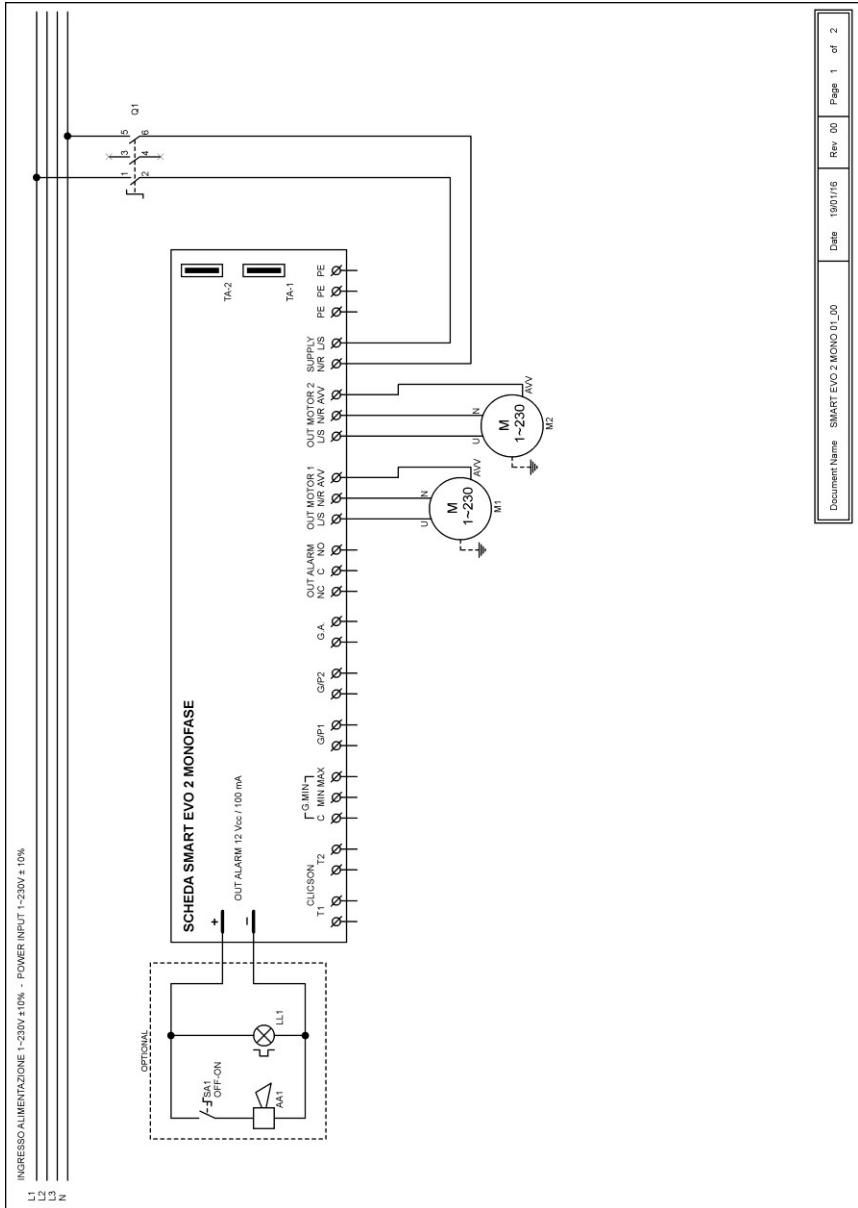

11.2 SMART EVO 2 Three phase (400V) circuit diagram

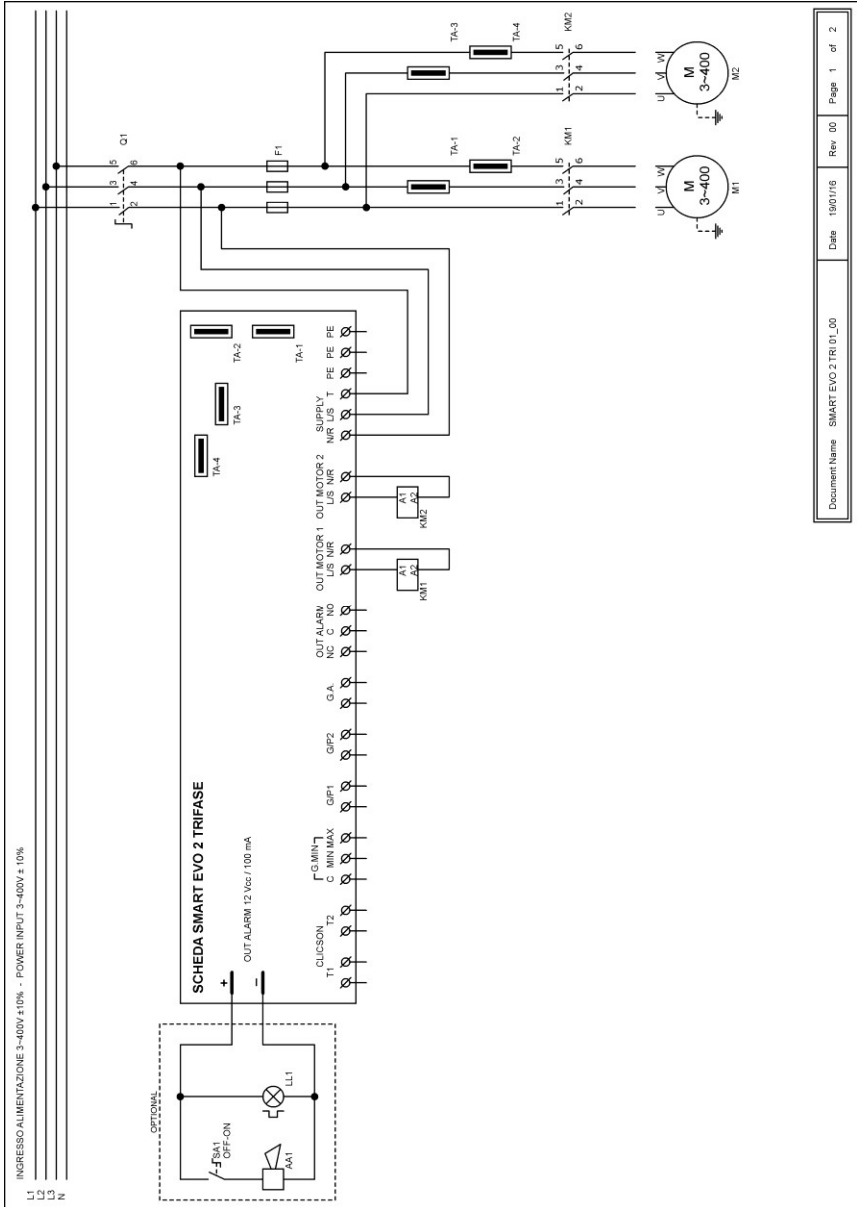

NOTE: On the three phase 230V version, the power supply and motors must be 3~230V.

12. STANDARD WIRING DIAGRAMS

12.1 SMART EVO 2 Single phase (230V) wiring diagram

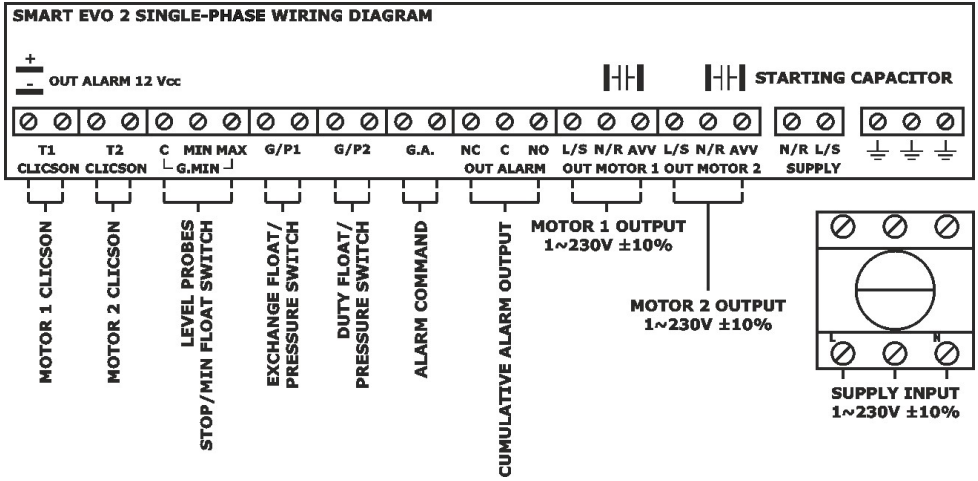

12.2 SMART EVO 2 Three phase (400V) wiring diagram

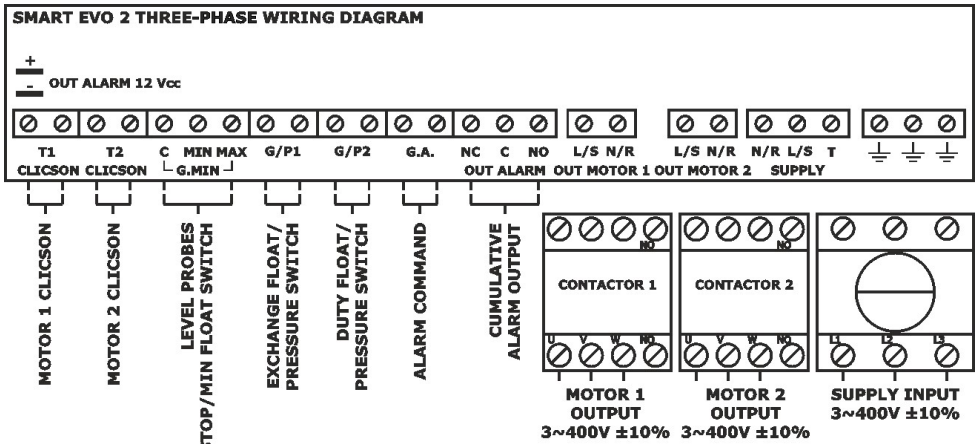

NOTE: On the three phase 230V version, the power supply and motors must be 3~230V.

13. APPLICATION AND INSTALLATION EXAMPLES

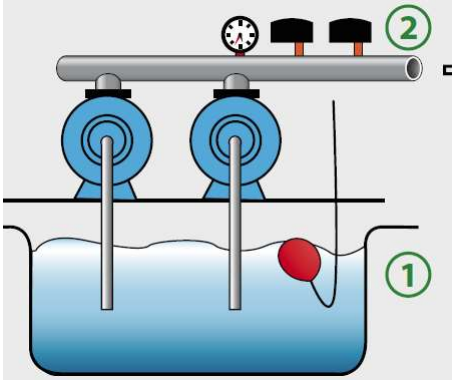

- ① LEVEL PROBES
Connect on C-MIN-MAX input
- ② PRESSURE SWITCHES
Connect on G/P1 and G/P2 input

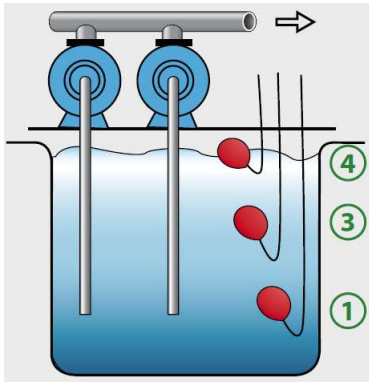

- ① MINIMUM LEVEL FLOAT SWITCH
Connect on C-MAX input
- ③ EXCHANGE FLOAT SWITCH
Connect on G/P1 input
- ④ EMERGENCY FLOAT SWITCH
Connect on G/P2 input

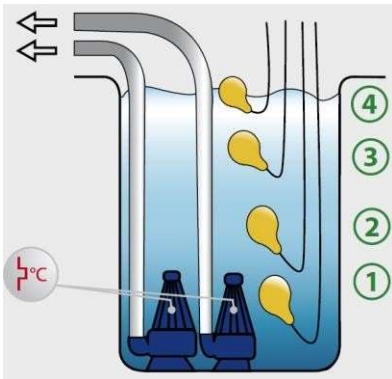

- ① STOP FLOAT SWITCH
Connect on C-MAX input
- ② EXCHANGE FLOAT SWITCH
Connect on G/P1 input
- ③ ASSIST FLOAT SWITCH
Connect on G/P2 input
- ④ ALARM FLOAT SWITCH
Connect on G.A. input

14. STANDARD DIMENSIONAL DIAGRAM

14.1 SMART EVO 2 Single phase dimensional

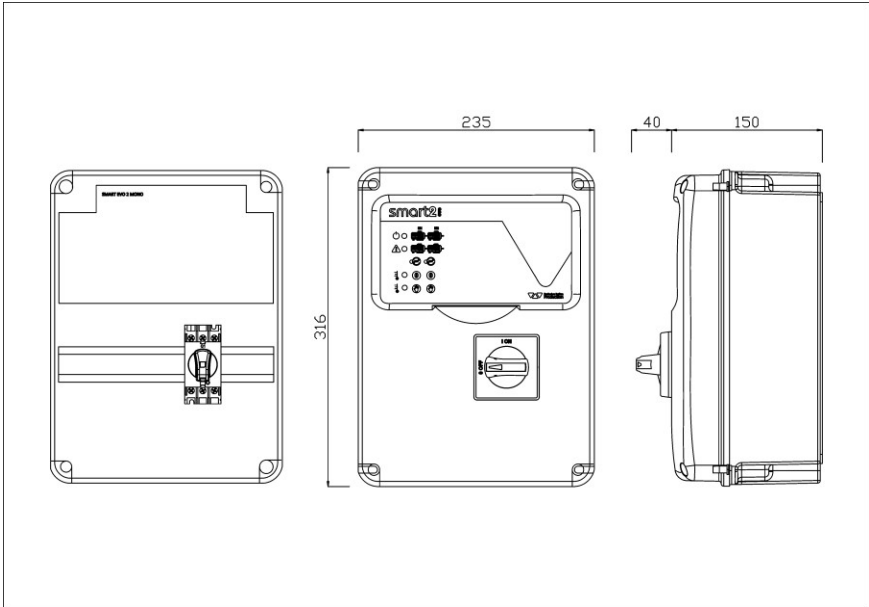

14.2 SMART EVO 2 Three phase 7.5 dimensional

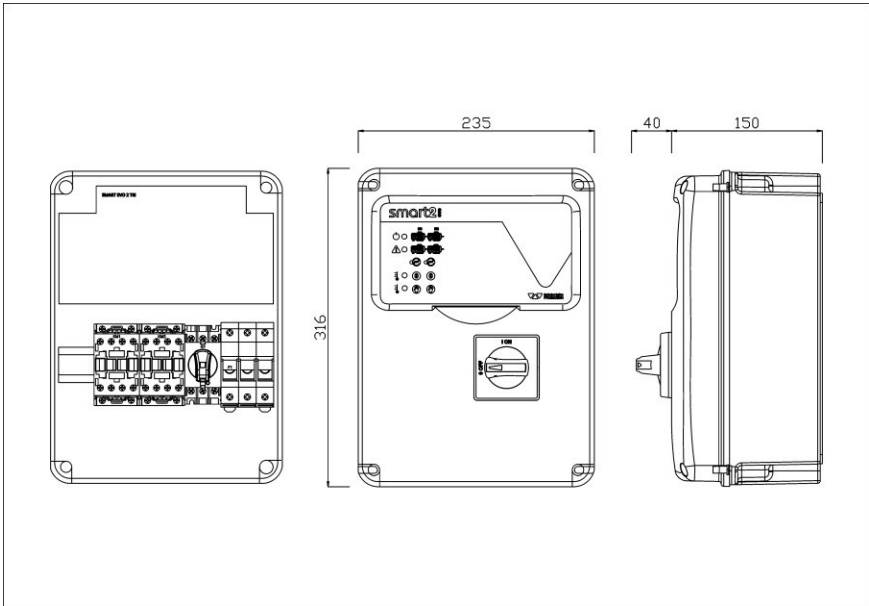

15. TROUBLESHOOTING

PROBLEMA	VERIFICHE / SOLUZIONI
THE PANEL IS POWERED UP BUT DOES NOT START UP IN AUTOMATIC MODE.	<ul style="list-style-type: none">• Check that the green led on the automatic mode button is lit; otherwise press the button.
THE PANEL IS SET TO AUTOMATIC MODE BUT THE PUMP DOES NOT START.	<ul style="list-style-type: none">• Ensure that inputs G/P1, G/P2 and C-MIN-MAX are closed.• Ensure correct operation of the floats.• Check that the normally open inputs are closed.• On the single-phase model, check that the 230V~ voltage is present on the motor output terminals L/S and N/R; on the three-phase model check that the 400V~ voltage is present on terminals L/S and N/R and that the contactor winding is powered.• Check settings of the DIP-SWITCHES (see page 13).
ON START-UP OF THE PUMP, THE THERMAL CUT-OUT TRIPS	<ul style="list-style-type: none">• Check the setting of the MAX trimmer or that the set current is approx. 15% higher with respect to the nominal motor current (see page 18).• Check that the thermal cut-out activation delay is sufficient on DIP SWITCH 2.
THE THERMAL CUT-OUT DOES NOT TRIP.	<ul style="list-style-type: none">• Check the setting of the MAX trimmer or that the set current is approx. 15% higher with respect to the nominal motor current (see page 18).
THE LIVE OUTPUT DOES NOT DELIVER 12 VDC	<ul style="list-style-type: none">• Check that the GA input closes in the event of an alarm.• Check settings of DIP-SWITCH 3.
THE PANEL IS IN MOTOR TEMPERATURE OVERLOAD ALARM STATUS	<ul style="list-style-type: none">• Check that jumpers are wired in on the motor clicson inputs T1 and T2 if the pumps are not fitted with a thermal cut-out.• Check settings of DIP-SWITCH 4.
NO LED LIGHTS UP ON THE CONTROL PANEL.	<ul style="list-style-type: none">• Check that the FLAT connector is inserted correctly.• Ensure that the door lock is set to ON.• On the panel input, check that the voltages 230V~ or 400V~ are present between the mains input terminals SUPPLY.• Check that the fuses are efficient.



AFPUMPS S.r.l.

Via dell'Artigianato, 4 - 35020 PERNUMIA (PADOVA) ITALY

 +39.0429.778295

 +39.0429.763049

 info@afpumps.com

Cod. MQ AN 0025 UK

Rev. 02

Em. 06.2019